



PIPE & COUPLING

**Cast Iron Soil Pipe & Fittings
Couplings & Gaskets**



11910 Country Road 492 • Tyler, Texas 75706
(800) 527-8478 • TylerPipe.com

GUIDE TO ORDERING:

1. To avoid errors, specify part numbers.
2. When selecting regular fittings, size of openings appear in this order:
 - a. Main
 - b. Branch or branches
3. When selecting reducing/increasing fittings, size appears as illustrated:

Hub & Spigot:

1. Spigot of Main
2. Hub of Main
3. Branch (Branches) or Side Openings
4. Length

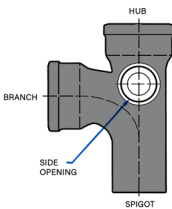

No Hub:

1. Bottom Outlet
2. Top Inlet
3. Branch (Branches) or Side Openings
4. Length

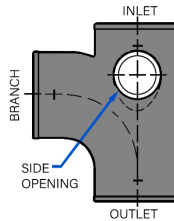

RH (Right Hand) Fittings Illustrated

4. When selecting long fittings, long bends are measured from the spigot (outlet) to the centerline of the hub (inlet); long branch fittings are measured from the spigot (outlet) to the base of the hub (inlet).
5. To specify right or left side openings, position fittings as follows and read left or right...
 - a. Bends, face open hub (inlet) with spigot (outlet) down.
 - b. Branch fittings, face open hub (inlet) of main with branch down.
6. All pipe and fittings are furnished coated.



STANDARDS & SPECIFICATIONS:

Piping to be installed for the various services shall be as specified or in accordance with local plumbing codes:

CURRENT STANDARDS

☛ NO-HUB® Cast Iron Soil Pipe and Fittings:

- CISPI 301..... (Cast Iron Soil Pipe Institute)
- ASTM A 888(American Society for Testing and Materials)

☛ NO-HUB® Couplings:

- CISPI 310.....(Cast Iron Soil Pipe Institute)
- ASTM C 1277(American Society for Testing and Materials)
- ASTM C 1540 (American Society for Testing and Materials)

☛ SV Hub and Spigot Cast Iron Soil Pipe and Fittings:

- ASTM A 74.....(American Society for Testing and Materials)

☛ Hub and Spigot Gaskets:

- ASTM C 564.....(American Society for Testing and Materials)

Please visit our website, www.tylerpipe.com, to find the most recent listings of our products. The information and dimensions in this product catalog are provided to accurately represent our products to the best of our knowledge and at the time of publication. However, because our products, including the specific information and dimensions in this catalog, may be added, changed or deleted from time to time, which we reserve the right to do in our sole discretion, we do not warrant the accuracy, completeness or usefulness of this information. Therefore, such information is made available solely for general information purposes, and any reliance you place on such information is strictly at your own risk. We disclaim all liability and responsibility arising from any reliance placed on such materials by you or by anyone who may be informed of any of its contents. If you have any questions or need additional information regarding specific product information or dimensions, please contact our technical services department.



NO-HUB SOIL PIPE AND FITTINGS

ADAPTER.....	37
BEND.....	8-13
CLEANOUT.....	38
CLOSET FITTING.....	29-33
CLOSET FLANGE.....	37
COMBINATION.....	20-21
CROSSES.....	22-23
FERRULE.....	25
FIGURE FITTING.....	34-36
INCREASER-REDUCER.....	25
PIPE.....	7
PLUG.....	25
REDUCER.....	26
SWEEP.....	13
TEE.....	14-17, 24
TRAP.....	27-28
WYE.....	18-19, 39

RUFWALL NO-HUB SPECIAL FITTINGS

APPLICATION.....	40
SPECIAL FITTING.....	49-51
BY-PASS.....	49
COMBINATION, LONG.....	50
SAN CROSS, TAPPED, EXTENDED.....	51
SAN TEE, DOUBLE SWEEP.....	49
SAN TEE, TAPPED, EXTENDED.....	51
SWEEP, EXTENDED.....	50
WASTE & VENT, LONG.....	50
STARTER FITTINGS.....	41-45
P-TRAP, SIDE INLET.....	46
TUB WYE.....	48

HUB & SPIGOT PIPE & FITTINGS

BEND.....	54-57
CLEANOUT.....	68-69



TABLE OF CONTENTS

COMBINATIONS SV.....	60-62,66
CROSSES.....	62-63,67
DOUBLE HUB.....	70
"H" BRANCH.....	61
INCREASER.....	70-71
OFFSET.....	57
PIPE.....	52-53
PLUG.....	68
REDUCER.....	69
SWEEP.....	56-57
TEE.....	57-58,60,65,68,86-87
TRAP.....	70-73
WYE.....	59,61,64,67

CHICAGO RUFWALL SV SPECIAL FITTINGS

BENDS, CLOSET.....	78,89-90
BYPASS.....	78
CROSS.....	80
STACK, SINK.....	79
TEE.....	78
LONG SWEEP.....	78
WASTE.....	80
WYE.....	78
BATH.....	78
DOUBLE.....	79
STARTER FITTINGS.....	74-77

COUPLINGS, GASKETS, LUBRICANT & TOOLS

NO-HUB COUPLINGS.....	81
TORQUE WRENCH.....	81
SV GASKETS.....	82
LUBRIFAST.....	83
TY-SEAL LUBRICANT.....	83
PIPE PULLER.....	84



STAPLE SPECIALS

ADAPTORS	85
CLEANOUT BODIES.....	85
CLEANOUT PLUGS, BRASS	90-91
CLEANOUTS, EXTENSION.....	85
CLOSET BENDS.....	89-90
CLOSET FLANGES.....	88
FERRULES.....	85
INSERTABLE JOINT.....	86
TEST TEE.....	86-87
VENT CAP.....	86

REFERENCE DATA

GUIDE TO ORDERING.....	INSIDE FRONT COVER
PIPE O.D.....	96
SUBMITTALS	
EZ-TITE GASKETS.....	97
TY-SEAL GASKETS.....	98-99
STANDARD NO-HUB COUPLINGS.....	100-101
NO-HUB CI SOIL PIPE & FITTINGS.....	102
HUB & SPIGOT CI SOIL PIPE & FITTINGS.....	103-104
QUESTIONS & ANSWERS.....	92-95

***CREATION OF THIRD PARTY REVIT/CAD DRAWINGS
WITHOUT AUTHORIZATION FROM TYLER PIPE IS
PROHIBITED**

WARNING! TESTING WITH COMPRESSED AIR OR GAS IN CAST IRON PIPE AND FITTINGS MAY RESULT IN EXPLOSIVE FAILURE AND COULD CAUSE SEVERE INJURY OR DEATH. TYLER PIPE RECOMMENDS HYDROSTATIC TESTING AS DESCRIBED IN THE CISPI HANDBOOK.

NEVER TEST CAST IRON PIPE OR FITTINGS WITH COMPRESSED AIR OR GAS!



NO-HUB PIPE



NO-HUB PIPE, TEN-FOOT LAYING LENGTH

Part Number	Diameter	Per Bundle Piece	Bundle Weight
006763	1½	54	1620
006770	2	64	2304
006787	3	48	2496
006794	4	30	2220
006800	5	24	2256
006817	6	21	2310
006824	8	15	2700
006831	10	8	2064
376583	12	6	1950
376590	15	3	1416

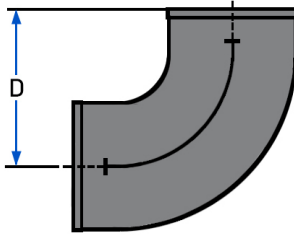

QUARTER BEND

Part No.	Size	D
006848	1½	4¼
006855	2	4½
006862	3	5
006879	4	5½
006886	5	6½
006893	6	7
006909	8	8½

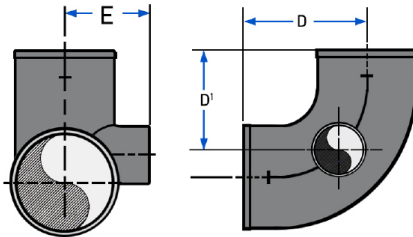

QUARTER BEND w/2" Side Opening

Part No.	Size	D	D¹	E
006923	3	5	4	3¼
006930	4	5½	4 ⁵ / ₁₆	3¾

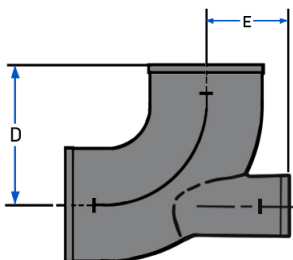

QUARTER BEND w/2" Heel Opening

Part No.	Size	D	E
006947	3	5	2 $\frac{7}{8}$
006954	4	5 $\frac{1}{2}$	3 $\frac{3}{4}$

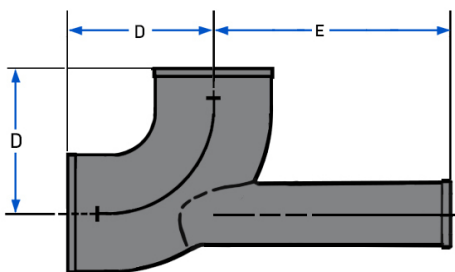

**QUARTER BEND WITH 2" EXTENDED
LOW HEEL INLET**

Part No.	Size	D	E
011019	3x2	5	10 $\frac{1}{2}$

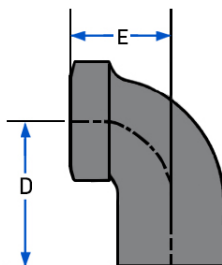

TAP SHORT QUARTER BEND

Part No.	Size	D	E
006961	1½x1½	3	2
006978	2x1¼	3¼	2¼
006985	2x1½	3¼	2¼
006992	2x2	3¼	2¼

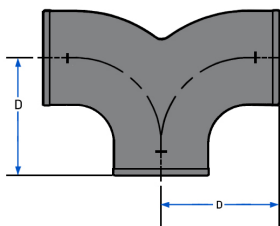

DOUBLE QUARTER BEND

Part No.	Size	D
007012	2	4½
007029	3	5
007036	4	5½

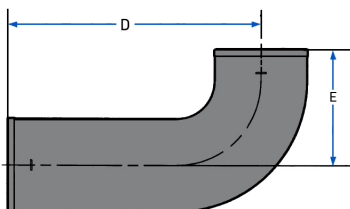

LONG QUARTER BEND

Part No.	Size	D	E
007067	2-12	12	4½
007043	2-14	14	4½
007050	2-16	16	4½
007074	2-18	18	4½
062875	2-24	24	4½
007081	3-12	12	5
007098	3-18	18	5
007104	4-12	12	5½

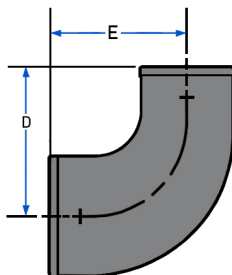

REDUCING QUARTER BEND (FLA. STYLE)

Part No.	Size	D	E
006916	4x3	5½	5

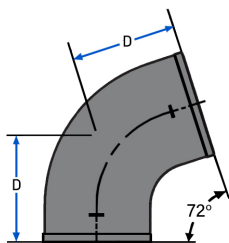

FIFTH BEND

Part No.	Size	D
007265	2	3 ¹ / ₁₆
007272	3	4 ¹ / ₁₆
007289	4	4 ⁷ / ₁₆

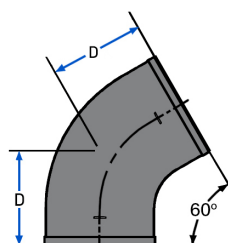

SIXTH BEND

Part No.	Size	D
007296	2	3 ¹ / ₄
007302	3	3 ¹ / ₂
007319	4	3 ¹³ / ₁₆

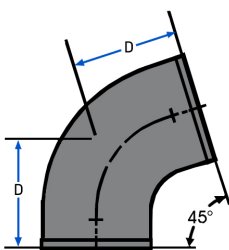

EIGHTH BEND

Part No.	Size	D
007326	1 ¹ / ₂	2 ⁵ / ₈
007333	2	2 ³ / ₄
007340	3	3
007357	4	3 ¹ / ₈
007364	5	3 ³ / ₈
007371	6	4 ¹ / ₁₆
007388	8	5
007395	10	5 ¹⁵ / ₁₆
376491	12	6 ⁹ / ₁₆
376675	15	7 ¹³ / ₁₆

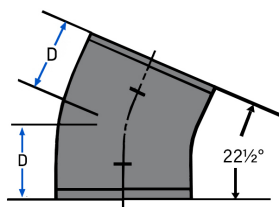

SIXTEENTH BEND

Part No.	Size	D
007487	1 ¹ / ₂	2 ¹ / ₈
007494	2	2 ¹ / ₈
007500	3	2 ¹ / ₄
007517	4	2 ⁹ / ₁₆
007524	5	2 ⁷ / ₈
007531	6	3
007548	8	3 ³ / ₄



PIPE & COUPLING

NO-HUB FITTINGS

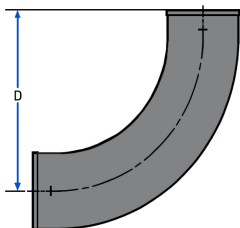

LONG SWEEP

Part No.	Size	D
007180	1½	9¼
007197	2	9½
007203	3	10
007258	4x3	10½
007210	4	10½
007227	5	11½
007234	6	12

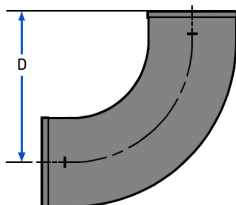

SHORT SWEEP

Part No.	Size	D
007111	2	6½
007128	3	7
007135	4	7½
007142	5	8½
007159	6	9
007166	8	10½
007173	10	12
376651	12	13¼
376668	15	14¾

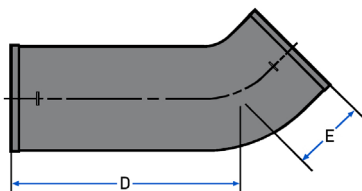

LONG EIGHTH BEND

Part No.	Size	D	E
382652	2-6	6	2¾
007401	2-12	12	2¾
007432	2-16	16	2¾
007456	2-18	18	2¾
007425	3-12	12	3
007463	3-18	18	3
007449	4-12	12	3½

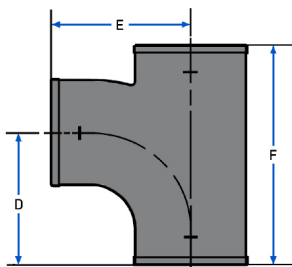

SAN TEE

Part No.	Size	D	E	F
007555	1½	4¼	4¼	6½
007562	2x1½	4¼	4½	6⅝
007579	2	4½	4½	6⅝
007586	3x1½	4¼	5	6½
007593	3x2	4½	5	6⅝
007609	3	5	5	8
007616	4x2	4½	5½	6⅝
007623	4x3	5	5½	8
007630	4	5½	5½	9⅝
007647	5x2	5	6	8½
007654	5x3	5½	6	9⅝
007661	5x4	6	6	10 ¹³ / ₃₂
007678	5	6½	6½	11 ¹ / ₁₆
007685	6x2	5	6½	8 ³ / ₁₆
007715	6x3	5½	6½	9 ³ / ₁₆
007692	6x4	6	6½	10 ¹ / ₁₆
382669	6x5	6½	7	11½
007708	6	7	7	12½
007722	8x3	6	7½	10⅝
007739	8x4	6½	7½	11½
007746	8x5	7	8	12½
007753	8x6	7½	8	13½
007760	8	8½	8½	15½

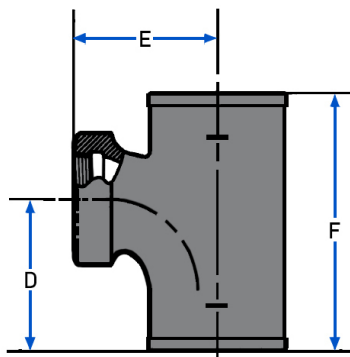

SAN TAP TEE

Part No.	Size x Tap	D	E	F
007968	1½ x 1¼	¾	2 ⁹ / ₁₆	5 ¹¹ / ₁₆
007975	1½	¾	2 ⁹ / ₁₆	5 ¹¹ / ₁₆
007982	2x1¼	¾	2 ¹³ / ₁₆	5 ¹¹ / ₁₆
007999	2x1½	¾	2 ¹³ / ₁₆	5 ¹¹ / ₁₆
008002	2	¾	3 ¹ / ₁₆	6 ³ / ₈
008019	3x1¼	¾	3 ⁵ / ₁₆	5 ¹¹ / ₁₆
008026	3x1½	¾	3 ⁵ / ₁₆	5 ¹¹ / ₁₆
008033	3x2	¾	3 ⁹ / ₁₆	6 ³ / ₈
008040	3	4 ⁷ / ₈	4 ³ / ₁₆	8
008057	4x1¼	¾	3 ¹³ / ₁₆	5 ¹¹ / ₁₆
008064	4x1½	¾	3 ¹³ / ₁₆	5 ¹¹ / ₁₆
008071	4x2	¾	4 ¹ / ₁₆	6 ³ / ₈
383277	4x3	4½	4 ³ / ₈	8
008095	5x1½	¾	4 ⁵ / ₁₆	6 ¹¹ / ₁₆
008101	5x2	4¼	4 ⁹ / ₁₆	7 ¹⁵ / ₁₆
008125	6x1½	¾	4 ¹³ / ₁₆	7 ¹⁵ / ₁₆
008132	6x2	4¼	5 ¹ / ₁₆	6¾

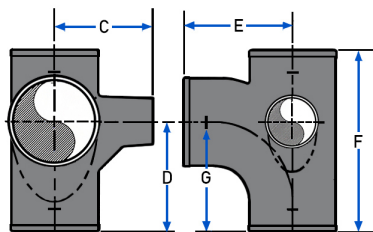

SAN TEE (w/2" 90° Side Opening Above Center)
New Orleans Code

Part No.	Size	Opening	C	D	E	F	G
007838	3	LH	4½	6	5	8½	5
007852	3	RH	4½	6	5	8½	5
007876	3	R&L	4½	6	5	8½	5
007845	4	LH	5	6½	5½	9⅝	5½
007869	4	RH	5	6½	5½	9⅝	5½
007883	4	R&L	5	6½	5½	9⅝	5½

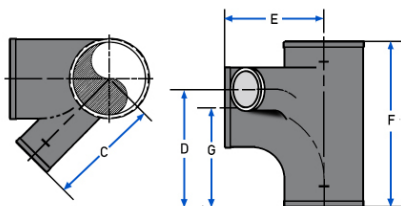

SAN TEE (w/2" 45° Side Opening Above Center)
New Orleans Code

Part No.	Size	Opening	C	D	E	F	G
007913	3	LH	5⅝	6	5	8½	5
007937	3	RH	5⅝	6	5	8½	5
387831	3	RL	5⅝	6	5	8½	5
007920	4	LH	6⅞	6½	5½	9⅝	5½
007944	4	RH	6⅞	6½	5½	9⅝	5½

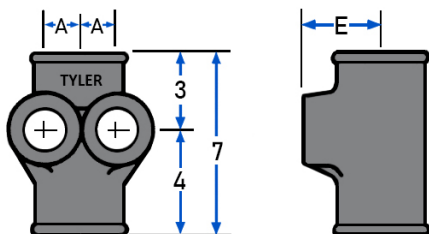

HORIZONTAL TWIN TAP TEE

Part No.	Size	A	E
008170	3x1½	1¾	3
008187	4x1½	1¾	3½

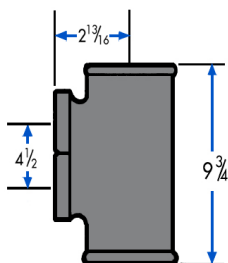

**DOUBLE VERTICAL
SAN TAP TEE**

Part No.	Size
008194	2x1½



**NO-HUB
FITTINGS**

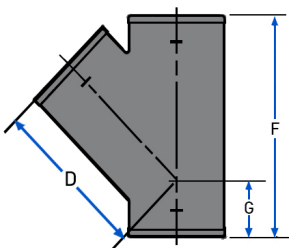

WYE

Part No.	Size	D	F	G
008200	1½	4	6	2
008217	2	4 ⁵ / ₈	6 ⁵ / ₈	2
383291	3x1½	4 ⁵ / ₈	6 ³ / ₁₆	2
008224	3x2	5 ⁵ / ₁₆	6 ⁵ / ₈	1½
008231	3	5 ³ / ₄	8	2¼
008248	4x2	6	6 ⁵ / ₈	1
008255	4x3	6½	8	1 ¹¹ / ₁₆
008262	4	7 ¹ / ₁₆	9½	2 ⁷ / ₁₆
008279	5x2	7½	8 ¹ / ₁₆	1 ⁵ / ₁₆
008286	5x3	8	9 ¹¹ / ₁₆	1 ¹¹ / ₁₆
008293	5x4	8½	11 ³ / ₁₆	2 ⁷ / ₁₆
008309	5	9½	12 ⁵ / ₈	3 ¹ / ₈
008316	6x2	8¼	8 ⁵ / ₁₆	½
008323	6x3	8¾	9¾	1¼
008330	6x4	9¼	11 ³ / ₁₆	1 ¹⁵ / ₁₆
008347	6x5	10¼	12½	2 ⁹ / ₁₆
008354	6	10¾	14 ¹ / ₁₆	3 ⁵ / ₁₆
008361	8x2	9 ³ / ₈	8½	9 ¹ / ₁₆
008378	8x3	9 ¹³ / ₁₆	9 ¹⁵ / ₁₆	1 ¹ / ₈
008385	8x4	10 ³ / ₈	11 ⁷ / ₁₆	1 ⁵ / ₁₆
008392	8x5	11 ³ / ₈	12 ¹³ / ₁₆	1 ⁵ / ₈
008408	8x6	11 ¹³ / ₁₆	14 ³ / ₁₆	2 ⁵ / ₁₆
008415	8	13 ³ / ₈	17 ¹ / ₈	3¾
008422	10x4	11 ¹¹ / ₁₆	12 ⁵ / ₈	¾
008439	10x6	13 ¹ / ₈	15 ¹ / ₁₆	2 ³ / ₁₆
008446	10x8	14 ¹¹ / ₁₆	18 ⁵ / ₈	3 ⁵ / ₈
008453	10	16½	21½	5 ¹ / ₁₆
376736	12	19¾	25½	5¾
376644	15	23¼	30	6¾

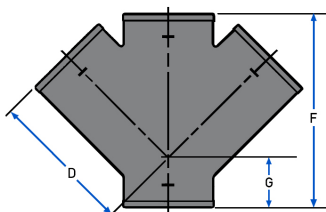

DOUBLE WYE

Part No.	Size	D	F	G
008538	2	4 ⁵ / ₈	6 ⁵ / ₈	2
008545	3x2	5 ⁵ / ₁₆	6 ⁵ / ₈	1 ¹ / ₂
008552	3	5 ³ / ₄	8	2 ¹ / ₄
008569	4x2	6	6 ⁵ / ₈	1 ¹ / ₂
008576	4x3	6 ¹ / ₂	8	1 ¹¹ / ₁₆
008583	4	7 ¹ / ₁₆	9 ¹ / ₂	2 ⁷ / ₁₆
008590	5x4	8 ¹ / ₂	11 ³ / ₁₆	2 ⁷ / ₁₆
008606	6x4	9 ¹ / ₄	11 ³ / ₁₆	1 ¹⁵ / ₁₆
008613	6	10 ³ / ₄	14 ¹ / ₁₆	3 ⁵ / ₁₆
274445	8x4	10 ³ / ₈	11 ⁷ / ₁₆	1 ⁵ / ₁₆
383093	8x6	11 ¹³ / ₁₆	14 ³ / ₁₆	2 ⁵ / ₁₆
008620	8	13 ³ / ₈	17 ⁷ / ₈	3 ³ / ₄

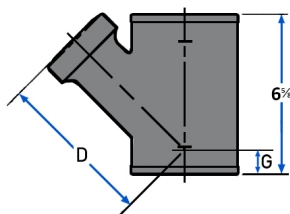

TAP WYE

Part No.	Size	D	G
008460	2x1 ¹ / ₂	5 ¹ / ₁₆	1 ⁵ / ₈
008477	2x2	5 ¹ / ₁₆	2
008484	3x1 ¹ / ₂	5 ³ / ₄	1 ¹ / ₂
008491	3x2	5 ¹³ / ₁₆	1 ¹ / ₂
008514	4x1 ¹ / ₂	6 ⁷ / ₁₆	1 ¹ / ₂
008521	4x2	6 ¹ / ₂	1 ¹ / ₂

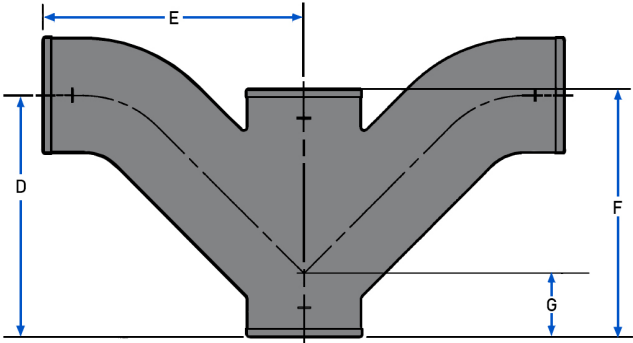

DOUBLE COMBINATION

Part No.	Size	D	E	F	G
009009	2	5 $\frac{3}{8}$	6 $\frac{1}{8}$	6 $\frac{5}{8}$	2
009016	3x2	5 $\frac{1}{2}$	6 $\frac{3}{4}$	6 $\frac{5}{8}$	1 $\frac{1}{2}$
009023	3	7 $\frac{7}{16}$	8	8	2 $\frac{1}{4}$
009030	4x2	5 $\frac{1}{2}$	7 $\frac{1}{4}$	6 $\frac{5}{8}$	1 $\frac{5}{8}$
009047	4x3	7 $\frac{1}{4}$	8 $\frac{1}{2}$	8	1 $\frac{11}{16}$
009054	4	9 $\frac{1}{4}$	10	9 $\frac{1}{2}$	2 $\frac{7}{16}$



NO-HUB FITTINGS

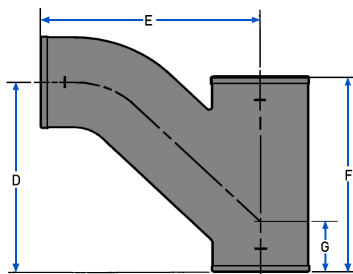

COMBINATION

Part No.	Size	D	E	F	G
008767	1½	4¾	5⅝	6	2
008774	2x1½	5	5⅞	6	2
008781	2	5⅝	6⅞	6⅝	2
383062	3x1½	5½	6¾	6⅝	1½
008798	3x2	5½	6¾	6⅝	1½
008804	3	7⅝	8	8	2¼
008811	4x2	5½	7¼	6⅝	1⅝
008828	4x3	7¼	8½	8	1⅞
008835	4	9¼	10	9½	2⅞
008842	5x2	5⅝	7¾	8⅞	1⅝
008859	5x3	7¾	9	9⅞	1⅞
008866	5x4	9¾	10½	11⅞	2⅞
008873	5	11¾	12½	12⅝	3⅞
008880	6x2	6	8¼	8⅝	½
008897	6x3	7⅞	9½	9¾	1¼
008903	6x4	9¾	11	11⅞	1⅝
008910	6x5	11⅞	13	12½	2⅞
008927	6	13⅝	14⅝	14⅞	3⅝
008934	8x4	9⅞	11⅝	11⅞	⅞
008941	8x6	12	13⅞	13⅝	2¼
008958	8	14¾	15⅝	16⅝	3¾

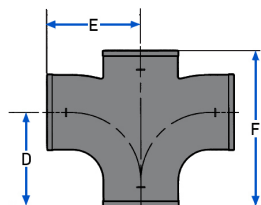

SAN CROSS

Part No.	Size	D	E	F
009061	1½	4¼	4¼	6½
009078	2	4½	4½	6⅞
009085	3x2	4½	5	6⅞
009092	3	5	5	8
009108	4x2	4½	5½	6⅞
009115	4x3	5	5½	8
009122	4	5½	5½	9⅞
009139	5x4	6	6	10⅞
009146	6x4	6	6½	10⅞
009153	6	7	7	12½
009160	8x4	6½	7½	11½
389866	8	8½	8½	15½

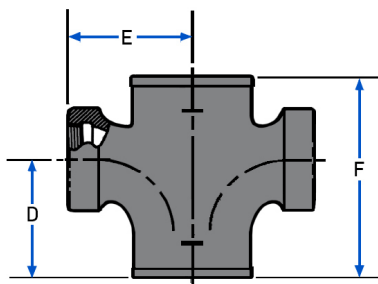

**SAN TAP CROSS
(No Baffle)**

Part No.	Size	D	E	F
009283	1½x1½	¾	2⅞	5⅞
009290	2x1¼	¾	2⅞	5⅞
009306	2x1½	¾	2⅞	5⅞
009313	2x2	¾	3⅞	6⅞
009337	3x1½	¾	3⅞	5⅞
009344	3x2	¾	3⅞	6⅞
009368	4x1½	¾	3⅞	5⅞
009375	4x2	¾	4⅞	6⅞
009382	6x1½	¾	4⅞	6⅞

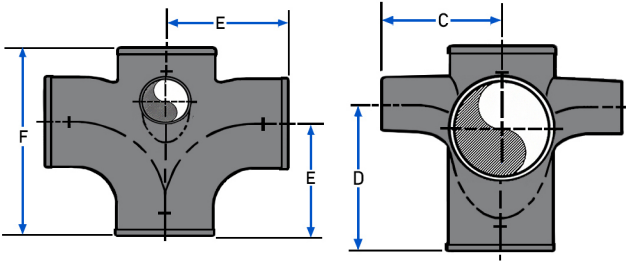

**SAN CROSS (w/2" 90° Opening Above Center)
New Orleans Code (No Baffle)**

Part No.	Size	(Inlets)	C	D	E	F
009221	3	(2)	4½	6	5	8½
009238	4	(1)	5	6½	5½	9⅝
009245	4	(2)	5	6½	5½	9⅝

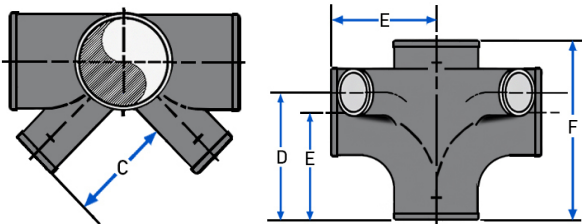

**SAN CROSS (with two 2" 45° San Openings– Same Side)
New Orleans Code (No Baffle)**

Part No.	Size	C	D	E	F
009252	3	5¾	6	5	8
009269	4	6⅞	6	5½	9⅝

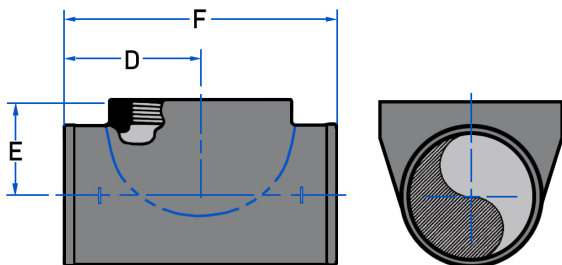

**TEST TEE
(Less Plug)**

Part No.	Size-IP	E	F	D
009429	2-2	2	6 ³ / ₈	3 ³ / ₁₆
009436	3-3	2 ¹¹ / ₁₆	7 ³ / ₄	3 ⁷ / ₈
009443	4-4	3	8 ⁷ / ₈	4 ⁷ / ₁₆
009450	5-5	4 ¹ / ₂	11 ¹ / ₂	5 ³ / ₄
009467	6-6	5	12 ¹ / ₂	6 ¹ / ₄
009474	8-8	6	15 ¹ / ₄	7 ⁵ / ₈
381501	10-10	6 ¹ / ₂	20	10

**TEST TEE
(w/ Type A Plug)**

Part No.	Size-IP	E	F	D
011736	2-2	2	6 ³ / ₈	3 ³ / ₁₆
011743	3-3	2 ¹¹ / ₁₆	7 ³ / ₄	3 ⁷ / ₈
011750	4-4	3	8 ⁷ / ₈	4 ⁷ / ₁₆
011767	5-5	4 ¹ / ₂	11 ¹ / ₂	5 ³ / ₄
011774	6-6	5	12 ¹ / ₂	6 ¹ / ₄
011781	8-8	6	15 ¹ / ₄	7 ⁵ / ₈



PIPE & COUPLING

NO-HUB FITTINGS

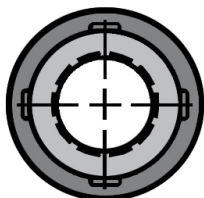

FERRULE (Less Plug)

Part No.	Size-IP	F
009979	2-1½	1¾
009986	3-2½	1¾
009993	4-3½	1¾
010005	5-4	3¾
010012	6-5	3¾ ₃₂
010029	8-6	3¾ ₃₂

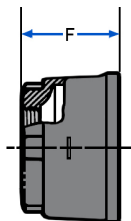

FERRULE (w/ Type A Plug)

Part No.	Size-IP	F
012108	2-1½	1¾
012115	3-2½	1¾
012122	4-3½	1¾
012139	5-4	3¾
012146	6-5	3¾ ₃₂
012153	8-6	3¾ ₃₂

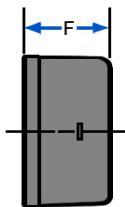

BLIND PLUG

Part No.	Size	F
010036	1½	1¾
010043	2	1¾
010050	3	1¾
010067	4	1¾
010074	5	1¾
010081	6	1¾
010098	8	2¼
010104	10	3
377535	12	3½
377542	15	3½

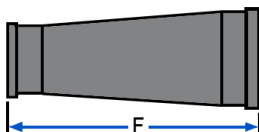

INCREASER REDUCER

Part No.	Size
009658	3x4

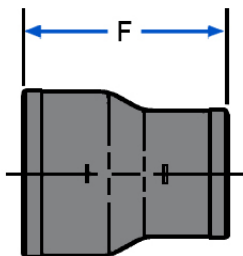

SHORT REDUCER

Part No.	Size	F
009665	2x1½	3⅝
382607	3x1½	3⅝
009672	3x2	3⅝
009689	4x2	3⅝
009696	4x3	3⅝
383314	5x2	4
009702	5x3	4
009719	5x4	4
009726	6x2	4
009733	6x3	4
009740	6x4	4
009757	6x5	4½
009764	8x2	4½
009771	8x3	4½
009788	8x4	4½
009795	8x5	5
009801	8x6	5
009818	10x4	5½
009825	10x6	6
009832	10x8	6
377559	12x4	6½
376507	12x6	6½
376514	12x8	7
376521	12x10	7½
377566	15x4	7
376750	15x6	7
376538	15x8	7
376545	15x10	7½
376552	15x12	7¾

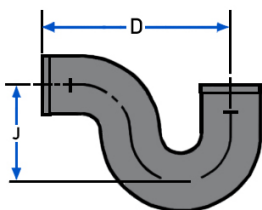

P-TRAP

Part No.	Size	D	J
010111	1½	6¾	3½
010128	2	7½	4
010135	3	9	5½
010142	4	10½	6½
010159	6	14	8½

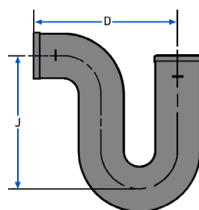

DEEP SEAL P-TRAP

Part No.	Size	D	J
010258	2	7½	7
010265	3	9	7
010272	4	10½	8

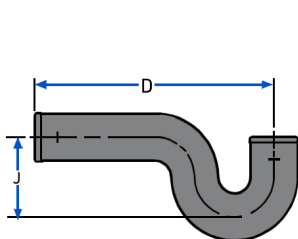

LONG P-TRAP

Part No.	Size	D	J
010166	2x12	12	4
010197	2x18	18	4

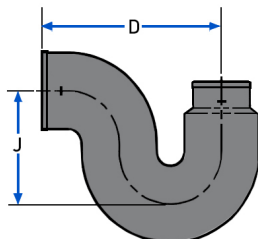

REDUCING P-TRAP

Part No.	Size	D	J
011231	3x2	9	5½

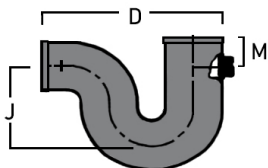

P-TRAP (w/1/2" Primer Tap)

Part No.	Size	D	J	M
011200	2	7½	4	2
011217	3	9	5½	2
011224	4	10½	6½	2

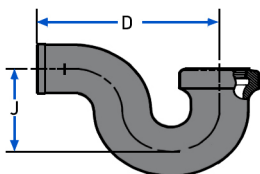

TAP P-TRAP

Part No.	Size	D	J
010340	1½	6¾	3½
010364	2x1½	7½	4
010371	2	7½	4

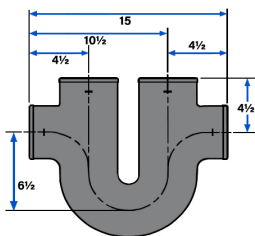

**RUNNING TRAP
w/TWO 4" VENTS**

Part No.	Size
010296	4

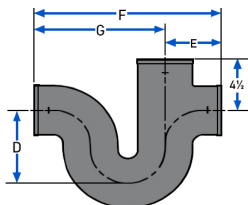

**RUNNING TRAP
w/4" SINGLE VENT**

Part No.	Size	D	E	F	G
010289	4	6½	4½	15	10½

***457-4" Stack, 4" Closet Waste, 2" Vent**
***458-4" Stack, 4" Closet Waste, 2" Waste, 2" Vent**

TOP VIEW

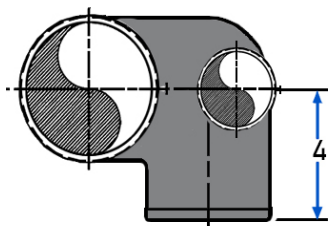

Right Hand Illustrated

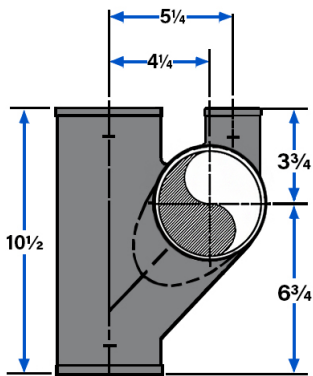

***9-457 VENTED CLOSET TEE (w/2" Top Vent)**

Part No.	Size
010470	4x4x2x4(R)
010487	4x4x2x4(L)

*** NOTE: Products on this page are not listed by I.A.P.M.O.**

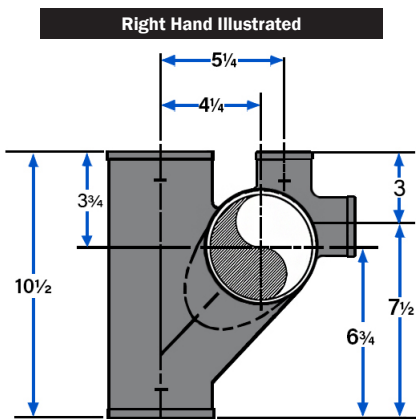
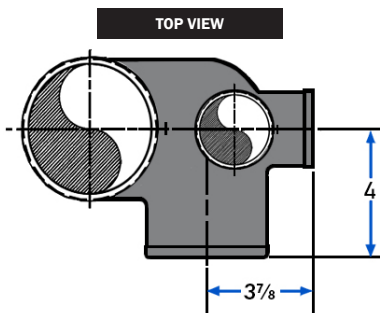

*** 9-458 VENTED CLOSET TEE
w/2" Top Vent and 2" Side Openings**

Part No.	Size
010494	4x4x2x2x4(R)
010500	4x4x2x2x4(L)

* NOTE: Products on this page are not listed by I.A.P.M.O.

***463-4" Stack, two 4"Waste, 2" Vent**
***464-4" Stack, two 4" Waste, 2" Waste, 2" Vent**

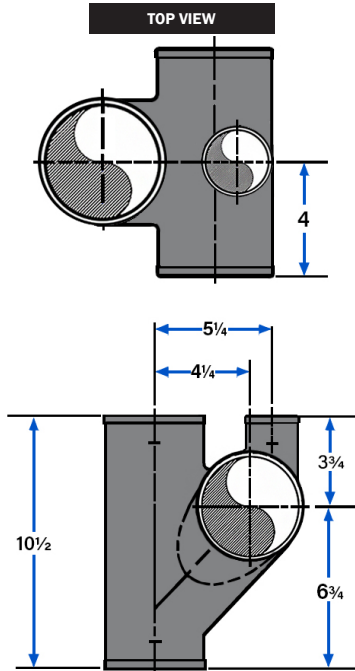

***9-463 VENTED CLOSET CROSS**
w/2" Top Vent (With Baffle)

Part No.	Size
010517	4x4x2x4x4

* NOTE: Products on this page are not listed by I.A.P.M.O.

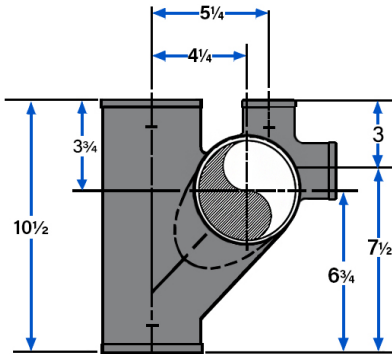
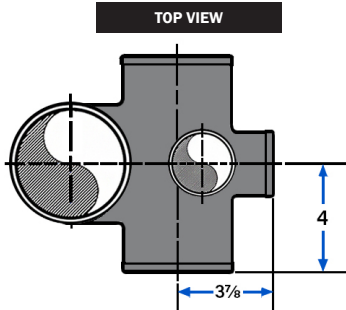

***9-464 VENTED CLOSET CROSS**
w/2" Top Vent and 2" Side Opening (No Baffle)

Part No.	Size
010531	4x4x2x2x4x4

* NOTE: Products on this page are not listed by I.A.P.M.O.

*** 399-4" Stack, two 4" Closet
Waste, two 2" Waste, 3" Vent**

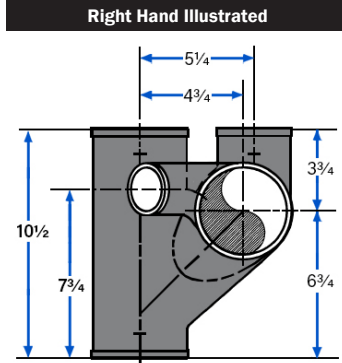
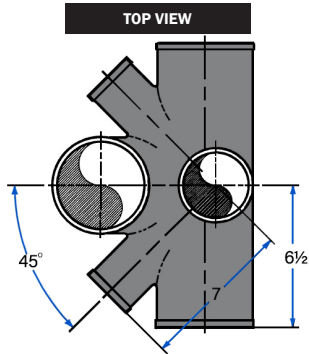

***9-399 VENTED CLOSET CROSS (No Baffle)**

Part No.	Size
010456	*4x3x2x4

* NOTE: Products on this page are not listed by I.A.P.M.O.

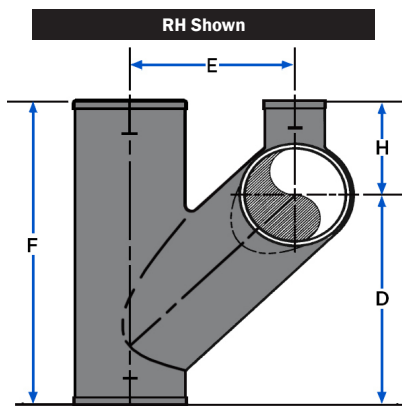
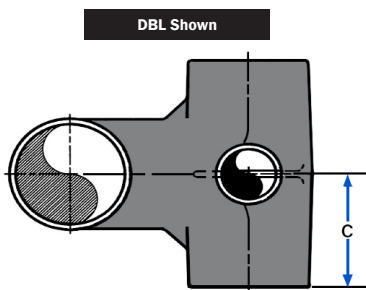

IAPMO FIGURE SIX DOUBLE, LR, RH (Full Baffle)

Part No.	Size	C	D	E	F	H
010791	3x2 (R)	4 ¹ / ₈	7 ⁹ / ₁₆	5 ¹ / ₁₆	11	3 ⁷ / ₁₆
010807	3x2 (L)	4 ¹ / ₈	7 ⁹ / ₁₆	5 ¹ / ₁₆	11	3 ⁷ / ₁₆
010838	3x2 (DBL)	4 ¹ / ₈	7 ⁹ / ₁₆	5 ¹ / ₁₆	11	3 ⁷ / ₁₆
010814	4x2 (L)	4 ¹ / ₂	9	6 ¹ / ₂	13	4
010821	4x2 (R)	4 ¹ / ₂	9	6 ¹ / ₂	13	4
010852	4x2 (DBL)	4 ¹ / ₂	9	6 ¹ / ₂	13	4

RH Shown

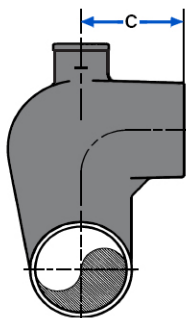

RH Shown

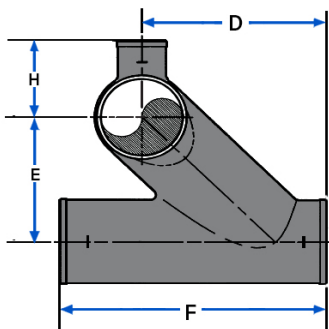

**IAPMO FIGURE EIGHT LH, RH, DBL
w/Full Baffle (RH Shown)**

Part No.	Size	C	D	E	F	H
010906	3x2 (R)	4 ¹ / ₈	7 ⁹ / ₁₆	5 ¹ / ₁₆	11	3 ⁷ / ₁₆
010913	3x2 (L)	4 ¹ / ₈	7 ⁹ / ₁₆	5 ¹ / ₁₆	11	3 ⁷ / ₁₆
010944	3x2 (DBL)	4 ¹ / ₈	7 ⁹ / ₁₆	5 ¹ / ₁₆	11	3 ⁷ / ₁₆
010920	4x2 (R)	4 ¹ / ₂	9	6 ¹ / ₂	13	4
010937	4x2 (L)	4 ¹ / ₂	9	6 ¹ / ₂	13	4
010999	4x2 (DBL)	4 ¹ / ₂	9	6 ¹ / ₂	13	8 EXTENDED

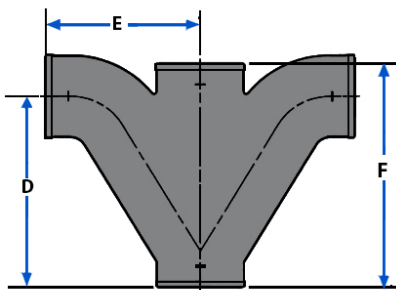

IAPMO FIGURE FIVE

Part No.	Size	D	E	F
010722	2	6½	5	8
010739	3x2x3x3	8⅞	6⅞	9¼
010746	3	8⅞	6⅞	10⅞
010753	4x2x4x4	10¼	7¾	11½
010760	4	10¼	7¾	12

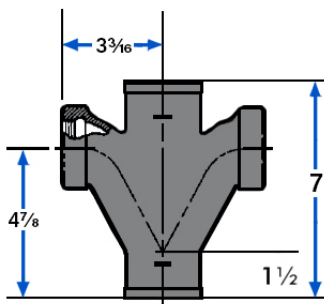

IAPMO FIGURE ONE w/NO-HUB TOP

Part No.	Size
010661	2x2x1½x1½

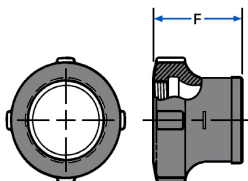

TAP ADAPTER

Part No.	Size x IPS Tap	F
009887	1½x1½	2 ⁵ / ₁₆
009900	2x1½	2 ³ / ₁₆
009917	2x2	2 ⁵ / ₁₆
009948	3x2	2 ³ / ₁₆

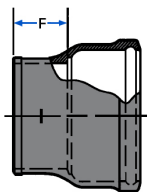

HUB ADAPTER No-Hub by SV Ty-Seal®

Part No.	Size	F
009849	2	2
009856	3	2
009863	4	2¼

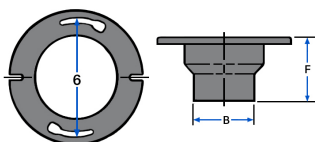

9-480 CLOSET FLANGE (Slot & Notch)

Part No.	Size	B	F
010593	4x3x3½	3 ⁵ / ₁₆	3½
010609	4x4x3½	4 ⁵ / ₁₆	3½
010616	4x4x4	4 ⁵ / ₁₆	4
383338	4x3x8	3 ⁵ / ₁₆	8
383345	4x4x8	4 ⁵ / ₁₆	8

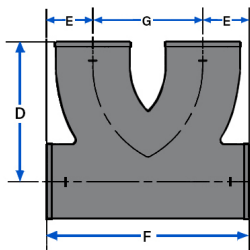

TWO WAY CLEANOUT

Part No.	Size	D	E	F	G
010654	4	8¼	2¾	12	6½

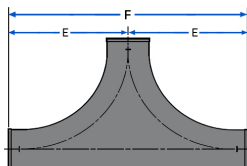

**TWO WAY CLEANOUT
East Bay Code**

Part No.	Size	E	F
010630	4	7½	15

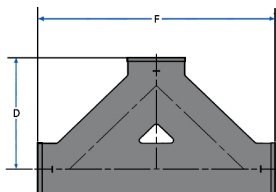

TWO WAY BAFFLE CLEANOUT

Part No.	Size	D	F
011163	3x3x4	9	15
011170	4x3x4	9½	19½
011187	4x4x4	9½	18¾

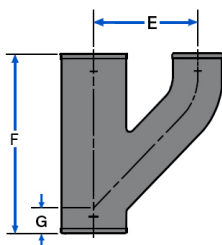

UPRIGHT WYE (Wide Center-Florida Special)

Part No.	Size	E	F	G
011293	4x2	7	11 $\frac{1}{16}$	1 $\frac{1}{16}$

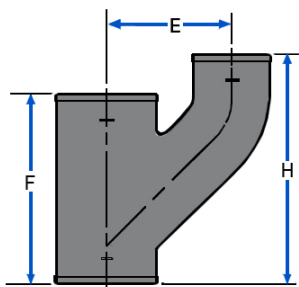

UPRIGHT WYE

Part No.	Size	E	F	H
008668	2	5 $\frac{1}{2}$	7	10 $\frac{1}{4}$
008675	3x2	5 $\frac{1}{2}$	7	9 $\frac{11}{16}$
008682	3	5 $\frac{1}{2}$	8 $\frac{3}{8}$	10 $\frac{5}{8}$
008699	4x2	5 $\frac{1}{2}$	7	9 $\frac{1}{4}$
008705	4x3	5 $\frac{1}{2}$	8 $\frac{3}{8}$	10 $\frac{1}{8}$
008712	4	6	9 $\frac{3}{4}$	11 $\frac{9}{16}$
008729	5x2	6 $\frac{3}{4}$	8	10
008750	5	7 $\frac{1}{8}$	12 $\frac{11}{16}$	14 $\frac{3}{16}$

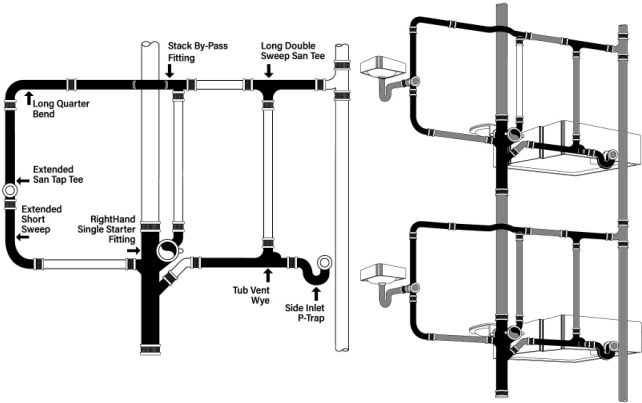

The **by-pass fitting** permits in-line piping to reduce width of the chase, and individual venting of the lavatories.

Tub wye fittings accept waste from two tubs and provide a common vent. They save space, materials and the labor to install duplicate systems.

RufWall Savings with Back Outlet Fixtures: (Compared with Conventional Piping)

- Fewer floor penetrations
- Eliminates cost of dropped ceilings to conceal pipe
- No scaffolding needed
- One-man installation
- Waist-high venting
- Water closet easier to install...faster

NOTE:

Rufwall fittings are sold and shipped as normal cataloged soil products. This publication contains the information needed to place orders with your customer service representative.

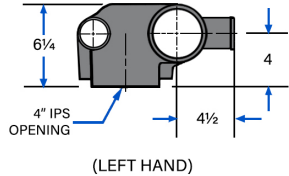
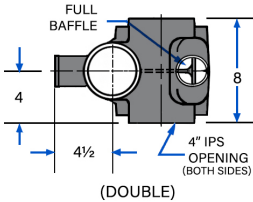

Part No.	Description (Double)
----------	----------------------

376071	700D (Plain)
376064	700D X 8 1/2
376088	800D-Z45°
376057	800D-X 8 1/2 -Z45°
018186	700D-X 8 1/2 -Z23 1/2°

Part No.	Description (Left Hand)
----------	-------------------------

376101	700L (Plain)
376125	700L X 8 1/2
376149	800L-Z45°
376163	800L-X 8 1/2 -Z45°
018360	700L-X 8 1/2 -Z23 1/2°

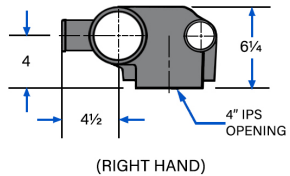
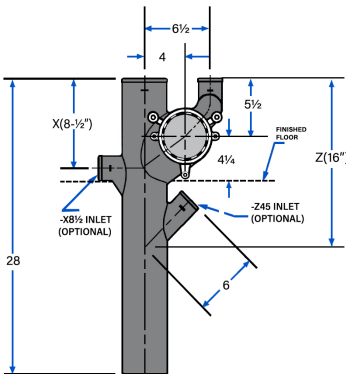

Part No.	Description (Right Hand)
----------	--------------------------

376095	700R (Plain)
376118	700R X 8 1/2
376132	800R-Z45°
376156	800R-X 8 1/2 -Z45°
018353	700R-X 8 1/2 -Z23 1/2°

Stack	4"
Waste.....	4"
Vent.....	2"
OPT Opening.....	2"

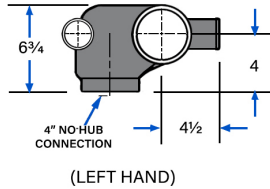
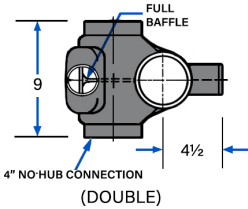

Part No.	Description (Double)
----------	----------------------

021292	710D (Plain)
021308	710D X 8 1/2
021322	810D-Z45°
297598	810D-X 8 1/2 -Z45°

Part No.	Description (Left Hand)
----------	-------------------------

021339	710L (Plain)
021353	710L X 8 1/2
021384	810L-Z45°
021407	810L-X 8 1/2 -Z45°

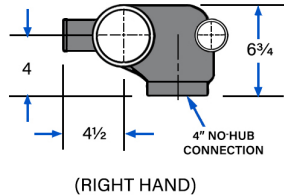
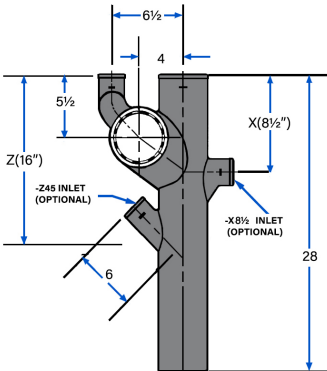

Part No.	Description (Right Hand)
----------	--------------------------

021346	710R (Plain)
021360	710R X 8 1/2
021391	810R-Z45°
021414	810R-X 8 1/2 -Z45°

Stack.....	4"
Waste.....	4"
Vent.....	2"
OPT Opening.....	2"

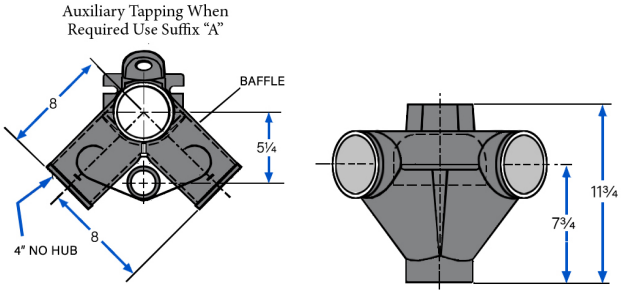

Part No.	Description
018667	9-502 (Plain)
018650	9-502-A

TAPPING DETAIL AUXILIARY BOSS

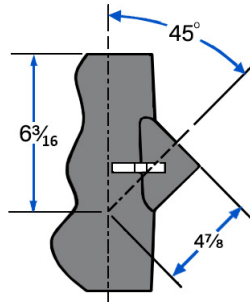

Stack.....	4"
Waste.....	4"
Vent.....	2"
OPT TAP "A".....	2"



NO-HUB STARTER FITTINGS (NO CONCEALED BAFFLE ON DOUBLES)



New York Vertical Stack Starter Fittings (Long Barrel)

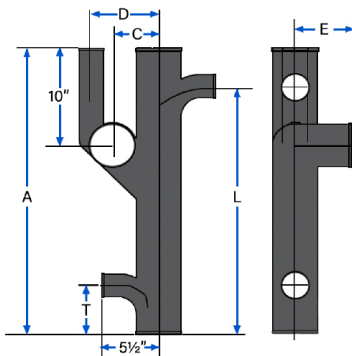

New York Vertical Stack Starter Fittings (Long Barrel)

Part No.	Description (Left Hand)	Size	A	L	C	D	E	T
019527	400L	4x30	30	0	4 1/2	6 1/2	5 1/2	0
390404	400L	4x30	30	6 1/2	4 1/2	6 1/2	5 1/2	0
019572	400L	4x30	30	12	4 1/2	6 1/2	5 1/2	0
019497	400L	4x30	30	26 1/2	4 1/2	6 1/2	5 1/2	0
390381	400L	4x30	30	0	4 1/2	6 1/2	5 1/2	4
390428	400L	4x30	30	26 1/2	4 1/2	6 1/2	5 1/2	4
390398	400L	4x30	30	0	4 1/2	6 1/2	5 1/2	6 1/2
390411	400L	4x30	30	6 1/2	4 1/2	6 1/2	5 1/2	6 1/2
390435	400L	4x30	30	26 1/2	4 1/2	6 1/2	5 1/2	6 1/2
019466	400L	4x30	30	0	4 1/2	6 1/2	5 1/2	12
019374	400L	4x30	30	26 1/2	4 1/2	6 1/2	5 1/2	12

Stack.....	4"
Waste.....	4"
Vent.....	2"



NO-HUB STARTER FITTINGS (NO CONCEALED BAFFLE ON DOUBLES)

New York Vertical Stack Starter Fittings (Long Barrel)

Part No.	Description (Right Hand)	Size	A	L	C	D	E	T
019510	400R	4x30	30	0	4½	6½	5½	0
390343	400R	4x30	30	6½	4½	6½	5½	0
019602	400R	4x30	30	12	4½	6½	5½	0
019480	400R	4x30	30	26½	4½	6½	5½	0
390329	400R	4x30	30	0	4½	6½	5½	4
390367	400R	4x30	30	26½	4½	6½	5½	4
390336	400R	4x30	30	0	4½	6½	5½	6½
390350	400R	4x30	30	6½	4½	6½	5½	6½
390374	400R	4x30	30	26½	4½	6½	5½	6½
019459	400R	4x30	30	0	4½	6½	5½	12
019367	400R	4x30	30	26½	4½	6½	5½	12

New York Vertical Stack Starter Fittings (Long Barrel)

Part No.	Description (Double)	Size	A	L	C	D	E	T
019534	400D	4x30	30	0	4½	6½	5½	0
390282	400D	4x30	30	6½	4½	6½	5½	0
019589	400D	4x30	30	12	4½	6½	5½	0
390268	400D	4x30	30	0	4½	6½	5½	4
390275	400D	4x30	30	0	4½	6½	5½	6½
390312	400D	4x30	30	26½	4½	6½	5½	6½
019473	400D	4x30	30	0	4½	6½	5½	12
019381	400D	4x30	30	26½	4½	6½	5½	12

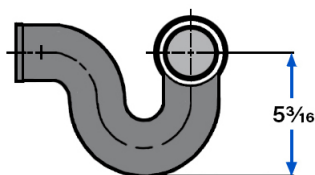
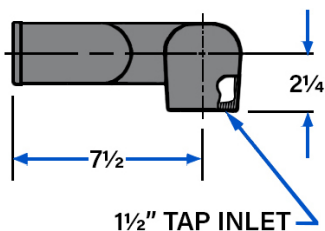

9-344 (LEFT HAND)

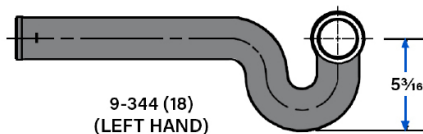
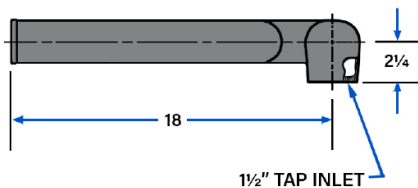

9-344 (18)
(LEFT HAND)

Part No.	Description
019220	9-344-LH
019237	9-344-RH
019244	9-344-LH (18)
019251	9-344-RH (18)

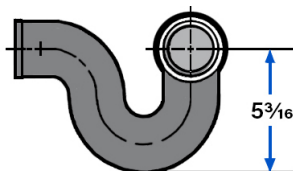
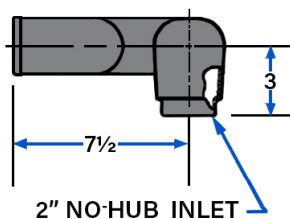

9-345 (LEFT HAND)

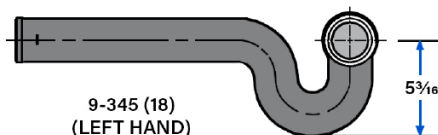
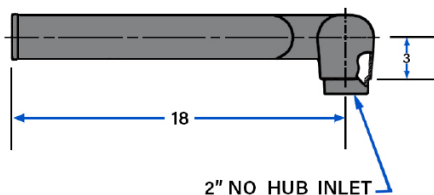

9-345 (18)
(LEFT HAND)

Part No.	Description
019268	9-345-LH
019275	9-345-RH
019282	9-345-LH (18)
019299	9-345-RH (18)

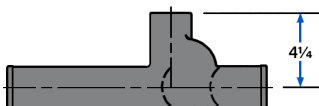
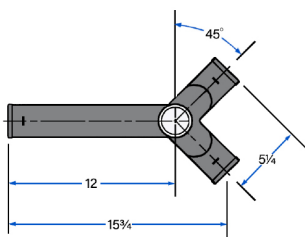
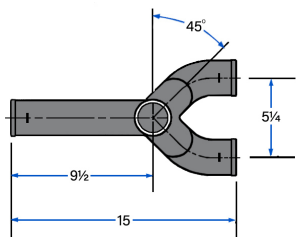

9-474

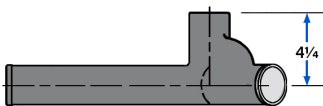

9-484

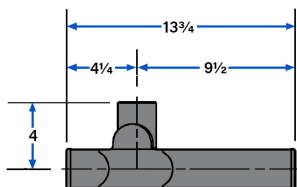
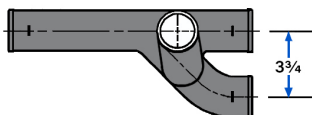
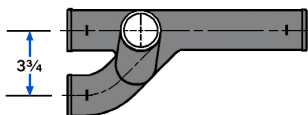

9-494-LH

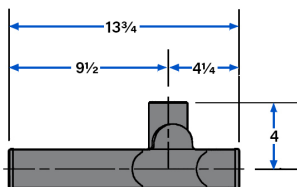

9-494-RH

VENTED TUB WYES

Part No.	Description
018155	9-474
018162	9-484
018131	9-494-LH
018148	9-494-RH

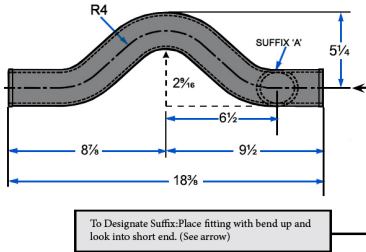

By-Pass Fitting

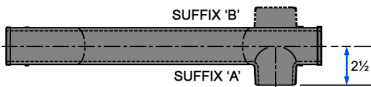

9-473

Part No.	Description
018735	9-473
018742	9-473-A
018759	9-473-B
018766	9-473-A/B

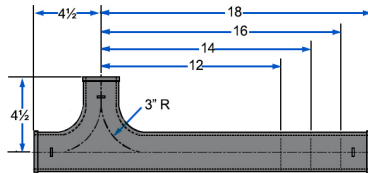

Double Sweep San Tee

9-301

Part No.	Description
019114	9-301 (2x12)
019138	9-301 (2x16)

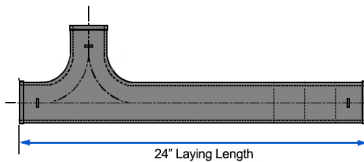

9-301

Part No.	Description
019145	9-301 (2x18)
062868	9-301 (2x24)

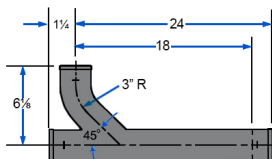

9-321 Long Combination

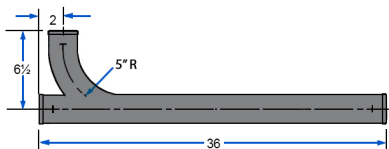

9-375 Long Waste & Vent Fitting

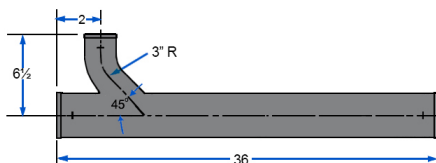

9-375-3x2 Long Waste & Vent Fitting

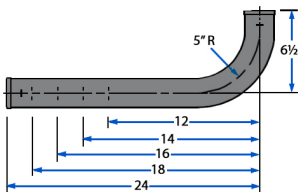

9-291 - Extended Short Sweep



9-376 Long Waste & Vent Sweep

Part No.	Description
019077	9-291 (2x12)
019084	9-291 (2x14)
019091	9-291 (2x16)
019107	9-291 (2x18)
019060	9-291 (2x24)
020431	9-376 (2x34)
019152	9-321 (2x18)
019053	9-321 (2x24)
020424	9-375 (2x36)
020417	9-375 (3x2x36)

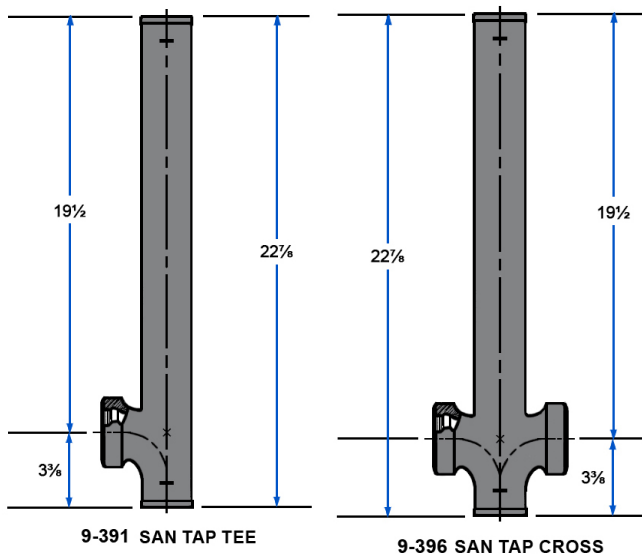

Extended Tees & Crosses

Part No.	Description
019305	9-391 (2x1½)
019312	9-391 (2x2)
019329	9-396 (2x1½)
019336	9-396 (2x2)



SERVICE CAST IRON SOIL PIPE



BUNDLED SV PIPE, SINGLE HUB

3½ - FOOT

Part No.	Size	Pcs.	Wt.
244059	2	102	1530
244066	3	60	1380
244073	4	46	1380
244080	5	32	1216
244097	6	24	1080
000273	8	15	1170
000280	10	8	928
000297	12	6	870
000303	15	3	615

5 - FOOT

Part No.	Size	Pcs.	Wt.
000006	2x5	102	1836
000013	3x5	60	1680
000020	4x5	46	1932
000037	5x5	32	1536
000044	6x5	24	1320
000051	8x5	15	1500
000068	10x5	8	1200
000075	12x5	6	1140
000082	15x5	3	780

10 - FOOT

Part No.	Size	Pcs.	Wt.
000181	2x10	36	1368
000198	3x10	36	1872
000204	4x10	27	2052
000211	5x10	24	2328
000228	6x10	18	2070
000235	8x10	15	2850
000242	10x10	8	2160
000259	12x10	6	2130
000266	15x10	3	1545

*** NOTICE:** All references to "weights" in this catalog section are averages and refer to SHIPPING WEIGHT ONLY. Actual weights may vary in accordance with dimensional tolerances.

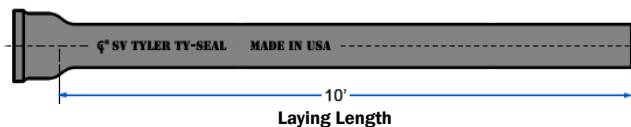
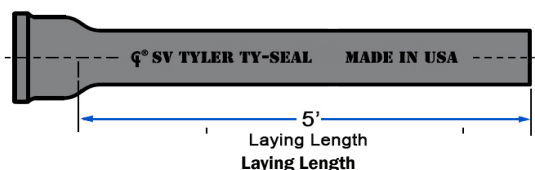
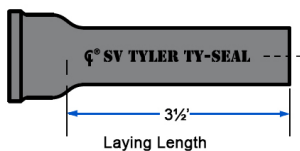

DOUBLE HUB, 30" LENGTHS

Part No.	Size
000310	2x30"
000327	3x30"
000334	4x30"

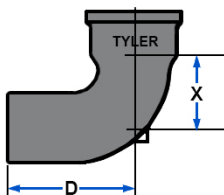

QUARTER BEND

Part No.	Size	X	D
000341	2	3¼	6
000358	3	4	7
000365	4	4½	8
000372	5	5	8½
000389	6	5½	9
000396	8	6⅝	11½
000402	10	7⅞	12½
000419	12	8¾	15
012894*	15	10¼	16½

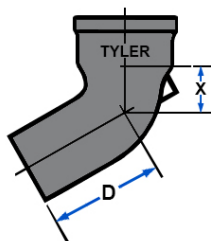

SIXTH BEND

Part No.	Size	X	D
000464	2	2	4¾
000471	3	2½	5½
000488	4	2 ¹³ / ₁₆	6 ⁵ / ₁₆
383116	5	3 ¹ / ₈	6 ⁶ / ₈
000495	6	3 ³ / ₈	6 ⁷ / ₈
028536	8	4 ¹ / ₈	9
000501	10	4 ¹ / ₁₆	9 ⁹ / ₁₆

* XH Only; XH Multiplier

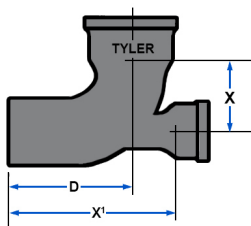

**QUARTER BEND
(w/ Low Heel Inlet)**

Part No.	Size	X	X¹	D
000716	3-2	4	9	7
000723	4-2	4½	10½	8

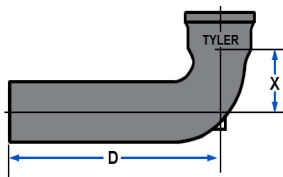

LONG QUARTER BEND

Part No.	Size	X	D
000792	2-12	3¼	12
000808	2-18	3¼	18
000815	3-12	4	12
000839	4-12	4½	12
000860	4-18	4½	18
000877	4-24	4½	24



PIPE & COUPLING

SERVICE FITTINGS

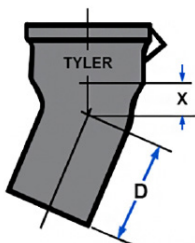

SIXTEENTH BEND

Part No.	Size	X	D
000600	2	$\frac{7}{8}$	$3\frac{5}{8}$
000617	3	$1\frac{3}{16}$	$4\frac{3}{16}$
000624	4	$1\frac{5}{16}$	$4\frac{13}{16}$
000631	5	$1\frac{3}{8}$	$4\frac{7}{8}$
000648	6	$1\frac{1}{2}$	5
000655	8	$1\frac{13}{16}$	$6\frac{11}{16}$
000662	10	2	$6\frac{7}{8}$
000679	12	$2\frac{3}{8}$	$8\frac{5}{8}$
063100*	15	$2\frac{1}{2}$	$8\frac{1}{8}$

* XH Only; XH Multiplier

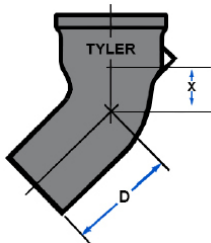

EIGHTH BEND

Part No.	Size	X	D
000518	2	$1\frac{1}{2}$	$4\frac{1}{4}$
000525	3	$1\frac{15}{16}$	$4\frac{15}{16}$
000532	4	$2\frac{3}{16}$	$5\frac{11}{16}$
000549	5	$2\frac{3}{8}$	$5\frac{5}{8}$
000556	6	$2\frac{9}{16}$	$6\frac{1}{16}$
000563	8	$3\frac{3}{8}$	8
000570	10	$3\frac{1}{2}$	$8\frac{3}{8}$
000587	12	$4\frac{1}{16}$	$10\frac{5}{16}$
013006*	15	$4\frac{11}{16}$	$10\frac{15}{16}$

* XH Only; XH Multiplier

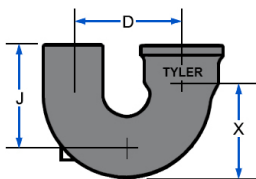

SINGLE HUB RETURN BEND

Part No.	Size	X	D	J
001027	3	6	7	7
001034	4	$6\frac{3}{4}$	8	$7\frac{1}{2}$

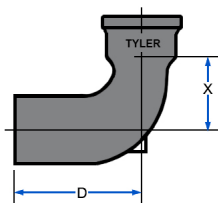

REDUCING QUARTER BEND

Part No.	Size	X	D
100089	3x2	$3\frac{3}{8}$	7
000747	4x2	$3\frac{1}{4}$	7
000754	4x3	$4\frac{1}{4}$	$8\frac{1}{8}$



PIPE & COUPLING

**SERVICE
FITTINGS**

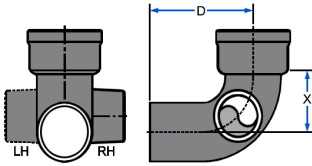

QUARTER BEND

(w/2" HUB SIDE OPENING)

Part No.	Size
047698	4(R)
047704	4(L)

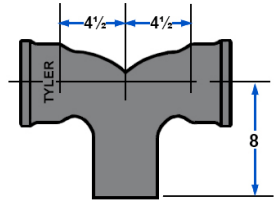

DOUBLE QUARTER BEND

Part No.	Size
392002	4

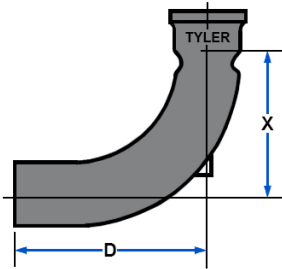

LONG SWEEP BEND, REDUCING

Part No.	Size	X	D
001188	3x2	9	12
001195	4x3	9½	13

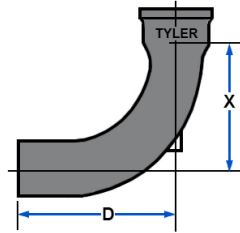

LONG SWEEP BEND

Part No.	Size	X	D
001041	2	8¼	11
001058	3	9	12
001065	4	9½	13
001072	5	10	13½
001089	6	10½	14
001096	8	11⅝	16½
382638	10	12⅝	17½
383581	12	13¾	20
063216*	15	15¼	21½

* XH Only; XH Multiplier



PIPE & COUPLING

SERVICE FITTINGS

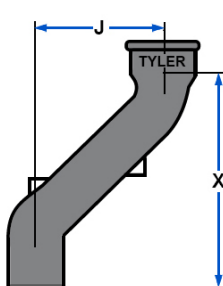

45 DEGREE OFFSET

Part No.	Size-Offset	X	J
003540	4" - 4"	11	4
003557	4" - 6"	13	6
003564	4" - 8"	15	8

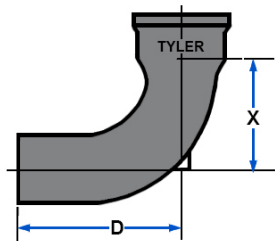

SHORT SWEEP BEND

Part No.	Size	X	D
001102	2	5¼	8
001119	3	6	9
001126	4	6½	10
001133	5	7	10½
001140	6	7½	11
001157	8	8⅝	13½
001164	10	9⅝	14½
383284	12	10¾	17

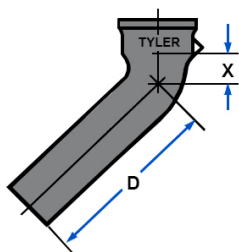

LONG EIGHTH BEND

Part No.	Size-Length	X	D
000983	3-12	1 ¹⁵ / ₁₆	12
000990	3-18	1 ¹⁵ / ₁₆	18
001003	4-12	2 ³ / ₁₆	12
001010	4-18	2 ³ / ₁₆	18
393023	6-18	2 ⁹ / ₁₆	18

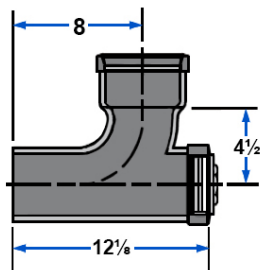

Sanitary Tee w/Cleanout on Main

Part No.	Size	IPS TAP
112822	4	3½

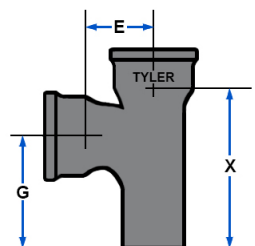

SAN TEE

Part No.	Size	X	E	G
001287	2	8	2 ³ / ₄	6 ¹ / ₄
001294	3x2	9	4	7
001300	3	10	4	7 ¹ / ₂
001317	4x2	9	4 ¹ / ₂	7
001324	4x3	10	4 ¹ / ₂	7 ¹ / ₂
001331	4	11	4 ¹ / ₂	8
001348	5x4	11	5	8
001355	5	12	5	8 ¹ / ₂
001362	6x2	9	5 ¹ / ₂	7
001379	6x3	10	5 ¹ / ₂	7 ¹ / ₂
001386	6x4	11	5 ¹ / ₂	8
001393	6	13	5 ¹ / ₂	9
001409	8x4	13	6 ¹ / ₂	9 ³ / ₄
001416	8x6	15	6 ¹ / ₂	10 ³ / ₄
001423	8	17	6 ⁵ / ₈	11 ³ / ₄
001430	10x4	13	7 ¹ / ₂	9 ³ / ₄
001447	10x6	15	7 ¹ / ₂	10 ³ / ₄
001454	10x8	17	7 ⁵ / ₈	11 ³ / ₄
001461	10	19	7 ⁵ / ₈	12 ³ / ₄
001478	12x6	16 ¹ / ₂	8 ¹ / ₂	12
001485	12x8	18 ¹ / ₂	8 ⁵ / ₈	13
001492	12x10	20 ¹ / ₂	8 ³ / ₄	14
001508	12	22 ¹ / ₂	8 ³ / ₄	15
001515	15x6	16 ¹ / ₂	10	12
001522	15x8	18 ¹ / ₂	10 ¹ / ₈	13
001546	15x12	22 ¹ / ₂	10 ¹ / ₄	15
013563*	15	25¹/₂	10¹/₄	16¹/₂

* XH Only; XH Multiplier

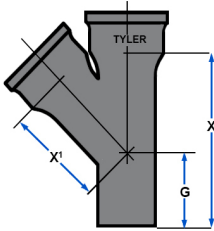

WYE

Part No.	Size	X	X'	G
001560	2	8	4	4
001577	3x2	9	5	4 ³ / ₁₆
001584	3	10 ¹ / ₂	5 ¹ / ₂	5
001591	4x2	9	5 ³ / ₄	3 ⁵ / ₈
001607	4x3	10 ¹ / ₂	6 ¹ / ₄	4 ⁷ / ₁₆
001614	4	12	6 ³ / ₄	5 ¹ / ₄
001621	5x2	9	6 ¹ / ₂	3 ³ / ₈
001638	5x3	10 ¹ / ₂	7	3 ⁷ / ₈
001645	5x4	12	7 ¹ / ₂	4 ¹¹ / ₁₆
001652	5	13 ¹ / ₂	8	5 ¹ / ₂
001669	6x2	9	7 ¹ / ₄	2 ⁹ / ₁₆
001676	6x3	10 ¹ / ₂	7 ³ / ₄	3 ³ / ₈
001683	6x4	12	8 ¹ / ₄	4 ³ / ₁₆
001690	6x5	13 ¹ / ₂	8 ³ / ₄	4 ¹⁵ / ₁₆
001706	6	15	9 ¹ / ₄	5 ³ / ₄
383482	8x2	10 ¹ / ₂	8 ¹ / ₂	3 ³ / ₈
387848	8x3	12	9	3 ¹⁵ / ₁₆
001713	8x4	13 ¹ / ₂	9 ¹ / ₂	4 ³ / ₄
001720	8x5	15	10	5 ¹ / ₂
001737	8x6	16 ¹ / ₂	10 ¹ / ₂	6 ⁵ / ₁₆
001744	8	19 ¹ / ₂	11 ¹³ / ₁₆	7 ¹ / ₁₆
001751	10x3	12	10 ³ / ₄	2 ³ / ₄
001768	10x4	13 ¹ / ₂	11 ¹ / ₈	3 ⁹ / ₁₆
001775	10x5	15	11 ⁵ / ₈	4 ⁵ / ₁₆
001782	10x6	16 ¹ / ₂	12 ¹ / ₈	5 ¹ / ₈
001799	10x8	19 ¹ / ₂	13 ⁷ / ₁₆	6 ¹ / ₂
001805	10	22 ¹ / ₂	14 ¹ / ₂	8
001812	12x4	15	12 ⁷ / ₁₆	4 ¹ / ₈
001829	12x5	16 ¹ / ₂	12 ¹⁵ / ₁₆	4 ⁷ / ₈
001836	12x6	18	13 ⁷ / ₁₆	5 ¹¹ / ₁₆
001843	12x8	21	14 ³ / ₄	7 ¹ / ₁₆
001850	12x10	24	15 ¹³ / ₁₆	8 ⁹ / ₁₆
001867	12	27	16 ¹ / ₈	10 ¹ / ₈
001874	15x4	15 ¹ / ₄	15	2 ¹ / ₂
001881	15x6	18	15 ³ / ₄	4
001898	15x8	21	17 ¹ / ₁₆	5 ³ / ₈
001904	15x10	24	18 ¹ / ₈	6 ¹ / ₈
001911	15x12	27	19 ³ / ₁₆	8 ⁷ / ₁₆
013853*	15	31¹/₂	20³/₄	10³/₄

*** XH Only; XH Multiplier**



COMBINATION

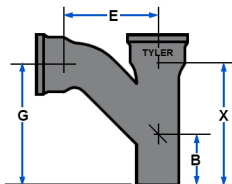

Part No.	Size	X	B	E	G
001966	2	8	4	4 ⁷ / ₈	7 ³ / ₈
001973	3x2	9	4 ³ / ₁₆	5 ³ / ₄	8 ³ / ₁₆
001980	3	10 ¹ / ₂	5	7	10 ¹ / ₁₆
001997	4x2	9	3 ¹ / ₁₆	6 ¹ / ₄	8 ³ / ₁₆
002000	4x3	10 ¹ / ₂	4 ¹ / ₂	7 ¹ / ₂	10 ¹ / ₁₆
002017	4	12	5 ¹ / ₄	9	12 ¹ / ₁₆
002024	5x2	9	3 ³ / ₈	6 ³ / ₄	8 ³ / ₈
383123	5x3	10 ¹ / ₂	4	8	10 ¹ / ₁₆
002031	5x4	12	4 ¹ / ₄	9 ¹ / ₂	11 ⁹ / ₁₆
002048	5	13 ¹ / ₂	5 ¹ / ₂	11	14 ¹ / ₈
002055	6x2	9	2 ¹ / ₁₆	7 ¹ / ₄	8 ³ / ₁₆
002062	6x3	10	3 ¹ / ₈	8 ¹ / ₂	9 ¹ / ₁₆
002079	6x4	12	4 ¹ / ₄	10	12 ¹ / ₁₆
388258	6x5	13 ¹ / ₂	5 ¹ / ₁₆	11 ¹ / ₂	14 ³ / ₁₆
002086	6	15	5 ³ / ₄	12 ¹ / ₈	16 ¹ / ₁₆
383611	8x2	10 ¹ / ₂	3 ¹ / ₈	8 ¹ / ₄	9 ⁵ / ₈
002093	8x4	13 ¹ / ₂	4 ³ / ₄	11	13 ⁹ / ₁₆
384748	8x5	15	5 ¹ / ₂	12 ¹ / ₂	15 ⁵ / ₈
002109	8x6	16 ¹ / ₂	6 ⁵ / ₁₆	13 ³ / ₈	17 ⁵ / ₈
002116	8	19 ¹ / ₂	7 ¹ / ₁₆	17	21 ⁹ / ₁₆

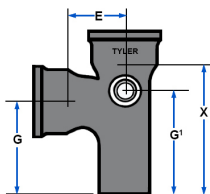

SAN TEE W/SIDE TAPS

Part No.	Size	X	E	G	G'
002369	4"w/2" R Tap	11	4 ¹ / ₂	8	9
002376	4"w/2" L Tap	11	4 ¹ / ₂	8	9
002383	4"w/2" L&R Tap	11	4 ¹ / ₂	8	9

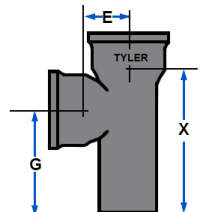

STRAIGHT TEE

Part No.	Size	X	G	E
001201	2	8	6 ¹ / ₄	1 ³ / ₄
001218	3x2	9	7	2 ¹ / ₂
001225	3	10	7 ¹ / ₂	2 ¹ / ₂
001232	4x2	9	7	3
001249	4x3	10	7 ¹ / ₂	3
001256	4	11	8	3
001263	6x4	11	8	4
001270	6	13	9	4
113324	8x4	12 ³ / ₈	9 ⁵ / ₈	5 ¹ / ₄

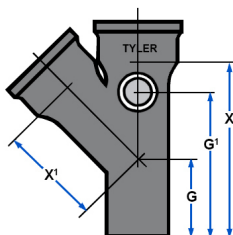

WYE (w/2" HUB SIDE OPENING)

Part No.	Size	X	X'	G	G'
002390	4R	12	6 ³ / ₄	5 ¹ / ₄	10
002406	4L	12	5 ³ / ₄	5 ¹ / ₄	19

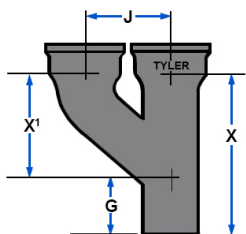

"H" BRANCH

Part No.	Size	X	X'	J	G
002222	2	10	6	4 ¹ / ₂	4
002239	3x2	10 ¹¹ / ₁₆	6 ³ / ₄	5	4 ³ / ₁₆
002246	3	12 ⁷ / ₁₆	7 ⁷ / ₁₆	5 ¹ / ₂	5
002253	4x3	12 ³ / ₁₆	7 ⁵ / ₁₆	6	4 ¹ / ₂
002260	4"	13 ¹⁵ / ₁₆	8 ¹¹ / ₁₆	6 ¹ / ₂	5 ¹ / ₄

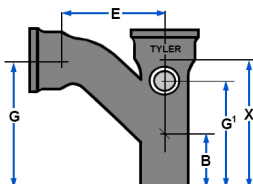

**COMBINATION
(w/2" HUB SIDE OPENING)**

Part No.	Size	X	B	E	G	G'
002413	4R	12	5 ¹ / ₄	9	12 ¹ / ₁₆	10
002420	4L	12	5 ¹ / ₄	9	12 ¹ / ₁₆	10

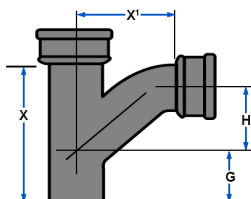

**COMBINATION
(SHORT TURN)**

Part No.	Size	G	H	X	X'
086192	4	5 ⁷ / ₁₆	4 ³ / ₈	11 ³ / ₈	6 ¹ / ₂

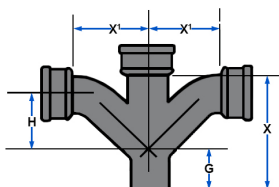

**DOUBLE COMBINATION
(SHORT TURN)**

Part No.	Size	G	H	X	X'
393245	4	5 ⁷ / ₁₆	4 ³ / ₈	11 ³ / ₈	6 ¹ / ₂

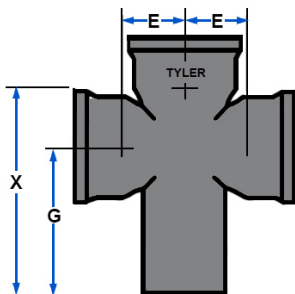

STRAIGHT CROSS

Part No.	Size	G	X	E	SV
102588	4x2	7	9	3	14
102595	4	8	11	3	18

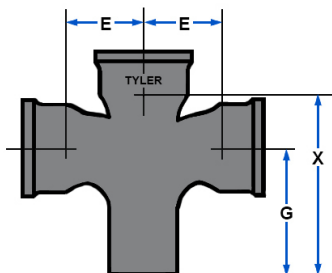

SAN CROSS (No Baffle)

Part No.	Size	X	E	G
002512	2	8	3¼	6¼
002529	3x2	9	4	7
002536	3	10	4	7½
002543	4x2	9	4½	7
002550	4x3	10	4½	7½
002567	4	11	4½	8
002574	5x4	11	5	8
102618	6x4	11	5½	8
383321	6	13	5½	9
002581	8x4	13	6½	9¾

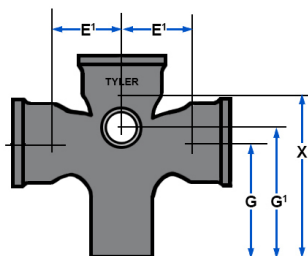

SAN CROSS W/2" SIDE OPENING

Part No.	Size (Side Opening)	X	E ¹	G	G ¹
002871	4 (1 side)	11	4½	8	9



DOUBLE WYE

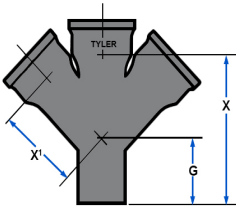

Part No.	Size	X	X ¹	G
002598	2	8	4	4
002604	3x2	9	5	4 ³ / ₁₆
002611	3	10 ¹ / ₂	5 ¹ / ₂	5
002628	4x2	9	5 ³ / ₄	3 ⁵ / ₈
002635	4x3	10 ¹ / ₂	6 ¹ / ₄	4 ⁷ / ₁₆
002642	4	12	9 ¹ / ₄	5 ¹ / ₄
392026	5	13 ¹ / ₂	8	5 ¹ / ₂
387855	6x3	10 ¹ / ₂	7	3 ⁵ / ₈
002659	6x4	12	8 ¹ / ₄	4 ³ / ₁₆
002666	6	15	9 ¹ / ₄	5 ³ / ₄
002673	8x4	13 ¹ / ₂	9 ¹ / ₂	4 ³ / ₄
002680	8x6	16 ¹ / ₂	10 ¹ / ₂	6 ⁵ / ₁₆
002697	8	19 ¹ / ₂	11 ¹³ / ₁₆	7 ¹¹ / ₁₆
383086	10x6	16 ¹ / ₂	12 ¹ / ₈	5 ⁵ / ₈
002703	10x8	19 ¹ / ₂	13 ⁷ / ₁₆	6 ¹ / ₂
002710	10	22 ¹ / ₂	14 ¹ / ₂	8
002727	12x8	21	14 ³ / ₄	7 ¹ / ₁₆
002734	12	27	16 ⁷ / ₈	10 ⁵ / ₈
063537*	15	31¹/₂	20³/₄	10³/₄

* XH Only; XH Multiplier

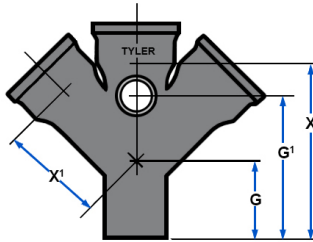

DOUBLE WYE (w/2" Hub Side Opening)

Part No.	Size	X	X ¹	G	G ¹
002932	4	12	9 ¹ / ₄	5 ¹ / ₄	10

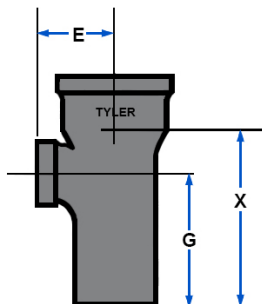

TAPPED SAN TEE

Part No.	Size x Tap	X	E	G
003137	2x1½	8	2 ¹³ / ₁₆	6¼
003144	2x2	8	3 ³ / ₁₆	6¼
003168	3x1½	9	3 ⁵ / ₁₆	7
003175	3x2	9	3 ⁹ / ₁₆	7
003182	3x3	10	3 ⁵ / ₁₆	7¼
003205	4x1½	9	3 ¹³ / ₁₆	7
003212	4x2	9	4 ¹ / ₁₆	7
399247	4x3	11	3 ¹⁵ / ₁₆	8

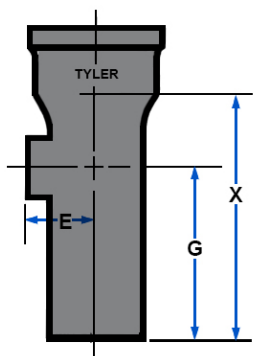

STRAIGHT TAPPED TEE

Part No.	Size	X	E	G
002963	2x1½	8	2	6¼
024507	2x2	8	2	6¼
002994	3x1½	9	2½	7
003007	3x2	9	2½	7
003045	4x2	9	3	7
392071	4x3	11	3	8
003106	6x4	13	4	9
003076	5x2	12	3½	7 ⁷ / ₈
003083	5x4	12	3½	8½
003090	6x2	13¼	3 ⁵ / ₈	9

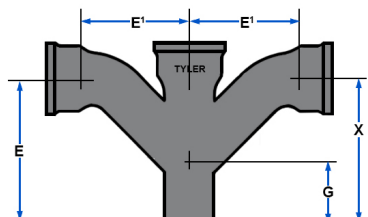

DOUBLE COMBINATION

Part No.	Size	X	E'	E	G
002758	2	8	4 ⁷ / ₈	7 ³ / ₈	4
002765	3x2	9	5 ³ / ₄	8 ³ / ₁₆	4 ³ / ₁₆
002772	3	10 ¹ / ₂	7	10 ¹ / ₁₆	5
002789	4x2	9	6 ¹ / ₄	8 ³ / ₁₆	3 ¹¹ / ₁₆
002796	4x3	10 ¹ / ₂	7 ¹ / ₂	10 ¹ / ₁₆	4 ¹ / ₂
002802	4	12	9	12 ¹ / ₁₆	5 ¹ / ₄
101925	5x4	12	9 ¹ / ₂	11 ⁹ / ₁₆	4 ¹ / ₄
002819	6x4	12	10	12 ¹ / ₁₆	4 ¹ / ₄
002826	6	15	12 ⁷ / ₈	16 ¹ / ₁₆	5 ³ / ₄

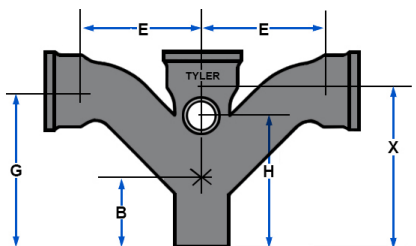

DOUBLE COMBINATION (w/2" HUB SIDE OPENING)

Part No.	Size	X	B	E	G	H
002949	4	12	5 ¹ / ₄	9	12 ¹ / ₁₆	10

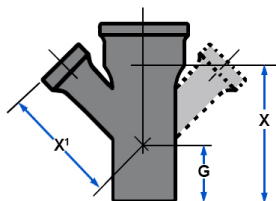

TAPPED WYE

Part No.	Size	X	X'	G
003236	3x2	9	6 ⁵ / ₈	4
003243	4x1 ¹ / ₂	9	7 ⁷ / ₈	5 ¹ / ₄
003250	4x2	9	7 ⁷ / ₈	5 ¹ / ₄

TAPPED DOUBLE WYE

Part No.	Size	X	X'
003441	4x2	9	7 ⁷ / ₈

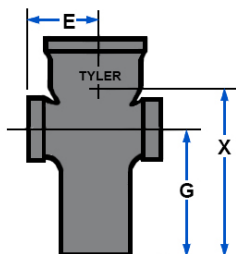

TAPPED SAN CROSS

Part No.	Size x Tap	X	E	G
003359	2x1 ¹ / ₂	8	4 ¹ / ₄	6 ¹ / ₄
003366	2x2	8	4 ¹ / ₄	6 ¹ / ₄
003397	3x2	9	4 ³ / ₄	7
003410	4x1 ¹ / ₂	9	5	7
003427	4x2	9	5	7

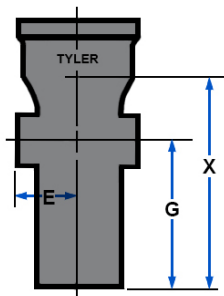

STRAIGHT TAPPED CROSS

Part No.	Size	X	E	G
003311	3x2	9	2 ¹ / ₂	7
003328	4x2	9	3	7
003335	5x2	9	5	7 ¹ / ₄

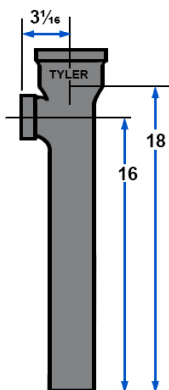

LONG TAP SAN TEE

Part No.	Size x Tap
380016	2x2-18



PIPE PLUG

Part No.	Size	F
004035	2	3 1/2
004042	3	3 3/4
004059	4	4
004066	5	4
004073	6	4
004080	8	4 1/2
004097	10	4 1/2
004103	12	5 1/4
063773*	15	5 1/4

* XH Only; XH Multiplier

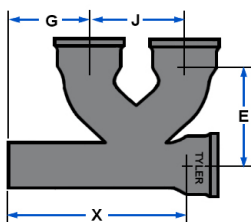

TWO-WAY CLEANOUT

Part No.	Size	X	E	G	J
003519	4	13 5/8	7 1/2	6 1/2	6 7/16
003533	6x6x4x4	13 5/8	8 1/2	6 1/2	6 7/16



PIPE & COUPLING

SERVICE FITTINGS

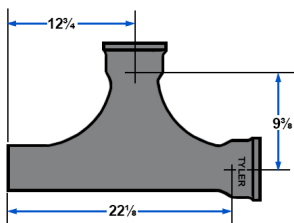

TWO-WAY CLEANOUT MEMPHIS CODE

Part No.	Size
003465	4

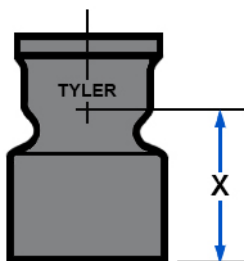

REDUCER

Part No.	Size	X
003588	3x2	4 ³ / ₄
003595	4x2	5
003601	4x3	5
383598	5x2	5
383604	5x3	5
003618	5x4	5
003625	6x2	5
003632	6x3	5
003649	6x4	5
003656	6x5	5
383352	8x3	6
003663	8x4	6
003670	8x5	6
003687	8x6	6
003694	10x4	6
383369	10x5	6
003700	10x6	6
003717	10x8	6
003724	12x4	6 ¹ / ₂
003731	12x6	6 ¹ / ₂
003748	12x8	6 ¹ / ₂
003755	12x10	6 ¹ / ₂
003762	15x6	6 ¹ / ₂
003779	15x8	6 ¹ / ₂
003786	15x10	6 ¹ / ₂
003793	15x12	6 ¹ / ₂

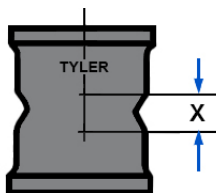

DOUBLE HUB FITTING

Part No.	Size	X
003960	2	1
003977	3	1
003984	4	1
003991	6	1
384755	8	1½
004004	10	1½
384762	12	1½
063711*	15	1½

* XH Only; XH Multiplier

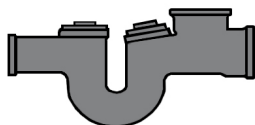

COMBINATION TRAP & TEE
(w/2 - 3½ A PLUGS)

Part No.	Size	Tap
112518	4x3	3½

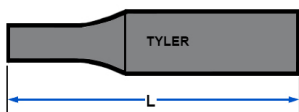

LONG PLAIN INCREASER*

Part No.	Size	L
003885	3x4	24
003892	4x5	30

**Not suitable for TY-SEAL Joint.
**Bead on 4" End.

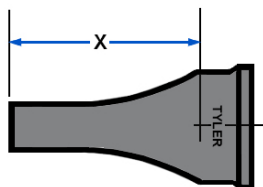

REGULAR INCREASER*

Part No.	Size	X
045939	2x4	9
003809	3x4	9
003816	4x5	9
003823	4x6	9
003830	4x8	12
277248	5x6	9½
003847	6x8	12
384724	8x10	12
003854	10x12	12

* The first size shown is the spigot end.

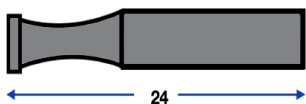

TAPPED LONG INCREASER

Part No.	Size	L
003939	2x4	24

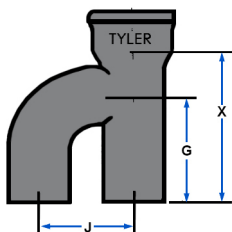

VENT BRANCH

Part No.	Size	X	G	J
002215	4	11	8	6½

RH Shown

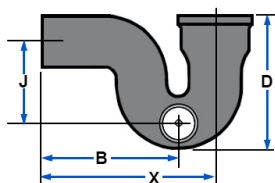

"P" TRAP w/3" CLEANOUT TAP, R, L

Part No.	Size	X	J	B	D
384779	4RH	14	6½	11	5½
384786	4LH	14	6½	11	5½

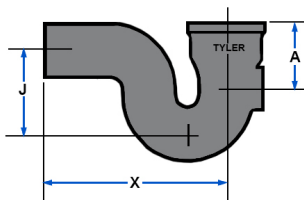

"P" TRAP w/½" HEEL TAP

Part No.	Size	X	J	A
004813	2	9½	4	3
004820	3	12	5½	3½
004837	4	14	6½	3½



“P” TRAP

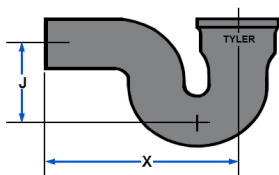

Part No.	Size	X	J
004486	2	9½	4
004493	3	12	5½
004509	4	14	6½
004516	5	15½	7½
004523	6	17	8½
004530	8	22¼	11½

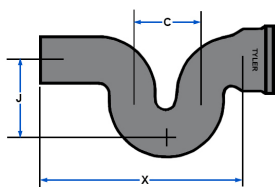

RUNNING TRAP

Part No.	Size	X	C	J
004578	4	17½	6	6½
004585	6	21½	8	8½

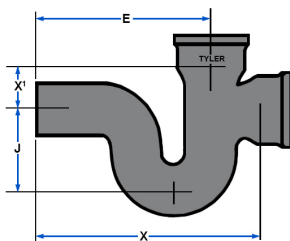

RUNNING TRAP w/HUB VENT

Part No.	Size	(Vent)	X	X'	E	J
004615	3	(3)	15	2½	12	5½
004622	4	(4)	17½	3	14	6½
004639	5	(4)	19½	3½	15½	7½
004646	6	(4)	21½	4	17	8½
004660	8	(6)	27%	5¾	22	11

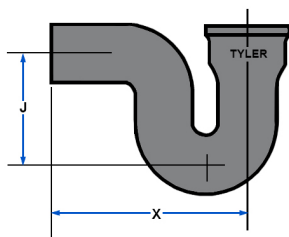

DEEP SEAL "P" TRAP

Part No.	Size	X	J
004844	2	9½	6
004851	3	12	7
004868	4	14	8
382614	6	17	9

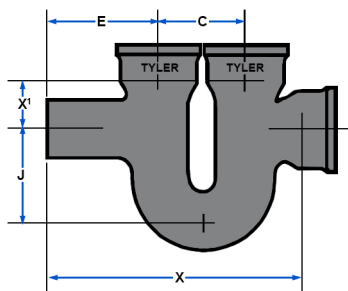

RUNNING TRAP w/TWO HUB VENTS

Part No.	Size	(Vent)	X	X¹	C	E	J
004707	3	(3-3)	15	2½	5	7	5½
004714	4	(4-4)	17½	3	6	8	6½
004721	5x4	(4-4)	19½	3½	7	8½	7½
004738	5	(4-4)	19½	3½	7	8½	7½
004745	6	(4-4)	21½	4	8	9	8½
053880	8	(4-4)	27⅝	5¼	10	12	11
004752	6	(6-6)	21½	4	8	9	8½
004769	8	(6-6)	27⅝	5¼	10	12	11
004776	10	(8-8)	31⅝	6¼	12	13	13
004783	12	(10-10)	38¾	7¼	15	16½	15
004790	15	(12-12)	45¾	8¾	18½	17¼	18½

STARTER FITTINGS

Note: For typical applications consult your local Tyler representative



PHOTOS ONLY SHOW 6½ INLET

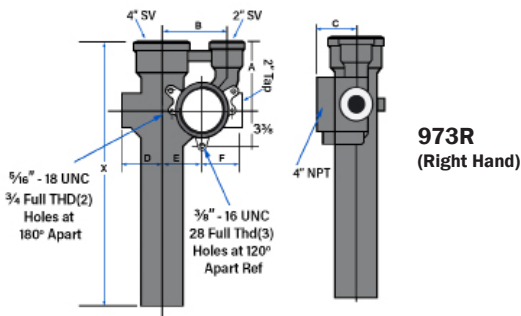

973R
(Right Hand)

SV 973R RIGHT HAND STARTER FITTING WITH 4" TAP AND 2" TAPPED "A" SIDE INLET

Part No.	Size	Inlet	A	B	C	D	E	F	X
107163	4	6½	6½	6½	4	4 1/16	4	4	25
107170	4	9½	9½	6½	4	4	4 1/16	4	25

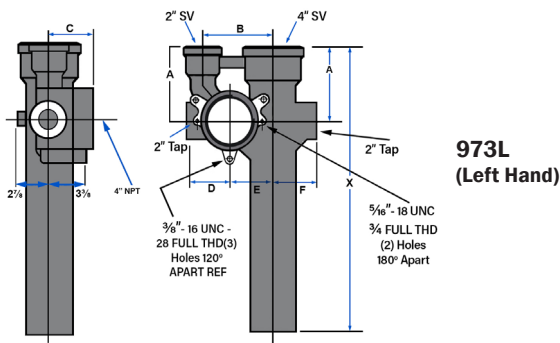

973L
(Left Hand)

SV 973L LEFT HAND STARTER FITTING WITH 4" TAP AND 2" TAPPED "A" SIDE INLET

Part No.	Size	Inlet	A	B	C	D	E	F	X
107194	4	6½	6½	6½	4	4	4	4	25
107217	4	9½	9½	6½	4	4	4	4	25

STARTER FITTINGS

Note: For typical applications consult your local Tyler representative

974R (Right Hand)

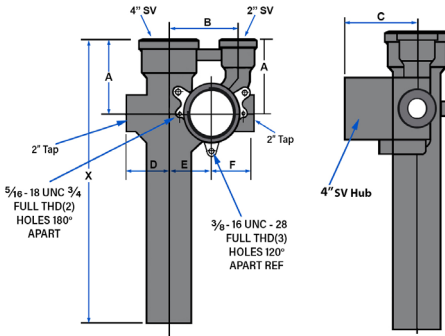

SV 974R RIGHT HAND STARTER FITTING WITH 4" HUB AND A/B INLETS

Part No.	Size	A	B	C	D	E	F	X
107231	4 (with A Inlet)	6 1/2	6 1/2	6 1/2	4 1/16	4	4	25
107236	4 (with A/B inlets)	6 1/2	18	6 1/2	6 1/2	-	-	25

974R (Right Hand) A&B Inlets

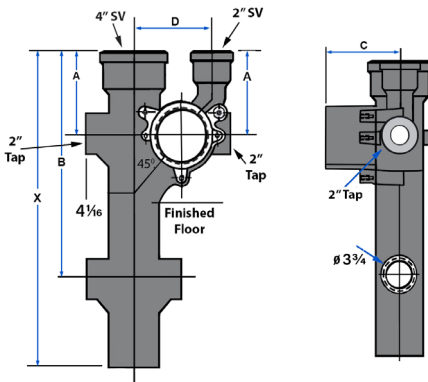



974L (Left Hand)

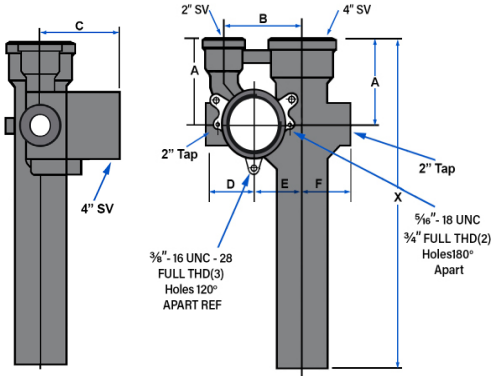

SV 974L LEFT HAND STARTER FITTING WITH 4" HUB AND A/B INLETS

Part No.	Size	A	B	C	D	E	F	X
107248	4 (with A Inlet)	6 1/2	6 1/2	6 1/2	4	4	4 1/16	25
107253	4 (with A/B inlets)	6 1/2	18	6 1/2	6 1/2	-	-	25

974L (Left Hand) A&B Outlets

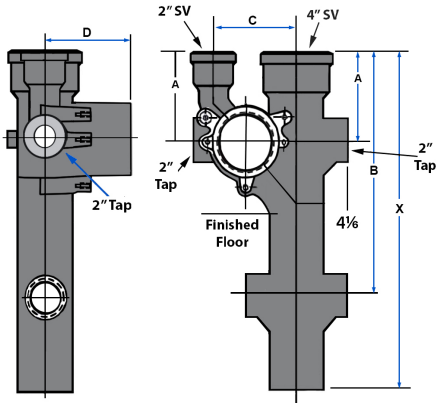



PIPE & COUPLING

STARTER FITTINGS

Note: For typical applications consult your local Tyler representative

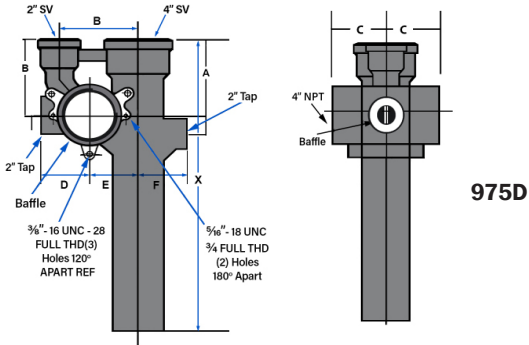

SV 975 DOUBLE STARTER FITTING WITH 4" TAP AND 2" TAPPED "A" SIDE INLET

Part No.	Item	Size	A	B	C	D	E	F	X
107255	975D	4	9½	6½	4	4	4	4¼ ₁₆	25

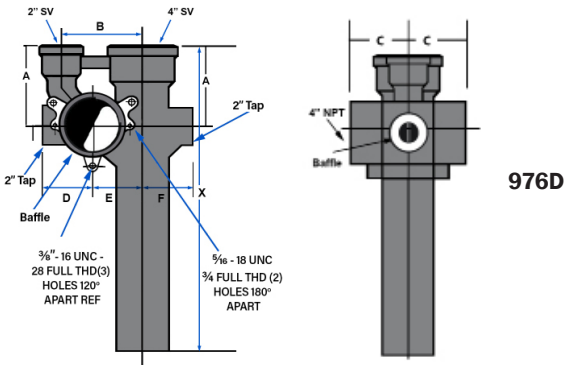

SV976 DOUBLE STARTER FITTING WITH 4" HUB AND 2" TAPPED "A" SIDE INLET

Part No.	Item	Size	A	B	C	D	E	F	X
107262	976D	4	6½	6½	6½	4	4	4¼ ₁₆	25



SERVICE SPECIAL FITTINGS

Note: For typical applications consult your local Tyler representative

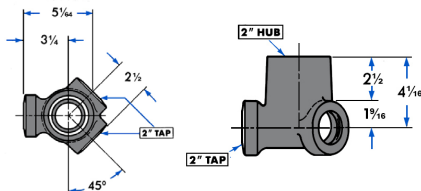

2" Tapped Bath Wye w/2" Hub Vent

Part No.	Item
005766	555C

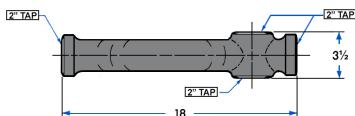
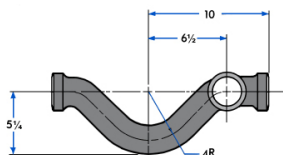

2" Tapped Vent Bypass w/two 2" side taps

Part No.	Item
005780	233C

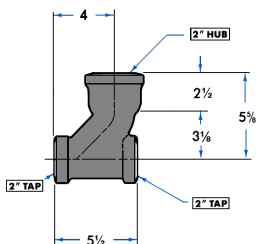

2" Tapped Long Sweep Tee (Taps on Run, Hub on Rise)

Part No.	Item
005773	491C

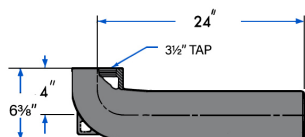

Tapped Closet Bends (4" Spigot, 3 1/2" on Rise) 3 1/2" Plug Not Included

Part No.	Item	Size
005803	410C	3 1/2x4-24



PIPE & COUPLING

SERVICE SPECIAL FITTINGS

Note: For typical applications consult your local Tyler representative

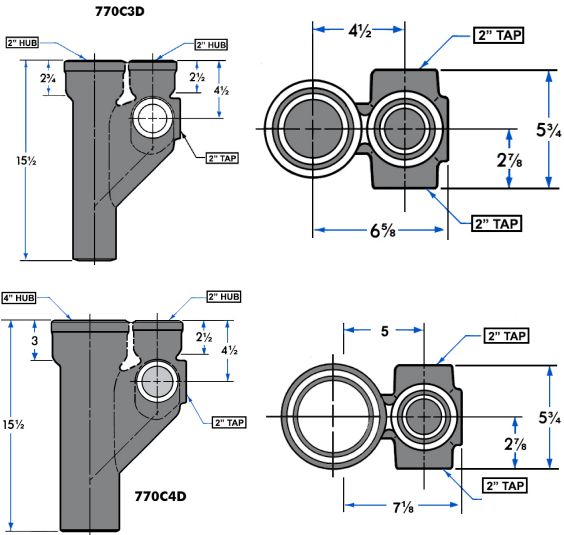

Sink Stack w/three 2" Waste Taps

Part No.	Item	Size
005827	770C3D	3x2
005834	770C4D	4x2

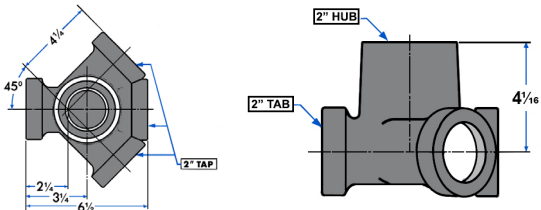

2" Tapped Double Wye w/2" Hub Vent

Part No.	Item
005841	560



SERVICE SPECIAL FITTINGS

Note: For typical applications consult your local Tyler representative

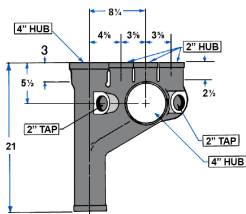
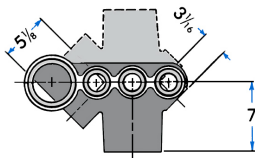

1739 Waste Tee/Cross w/Three 2" hubs and Two 2" Waste Tee Taps

Part No.	Item
005858	1739R
005865	1739L
005872	1739D

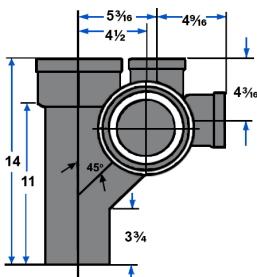

SV 458 Vented Closet Tee with 2" Top Vent and 2" Extended Side Inlet Right Hand or Left Hand (ILLUSTRATION SHOWS RIGHT HAND)

Part No.	Size
005575	4x4x2x2x4 RH
005582	4x4x2x2x4 LH

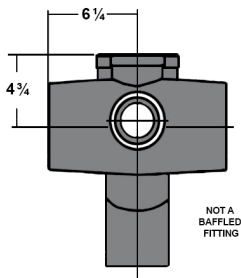

SV459D Vented Closet Cross with 2" Top Vent and 2" Extended Side Inlet

Part No.	Size
005599	4x4x2x2x4



NO-HUB COUPLINGS & TORQUE WRENCH



NO-HUB COUPLING ASSEMBLY

Part No.	Size & Description	Carton Quantity	Pallet Quantity
006206	1 1/2	100	3600
006213	2x1 1/2	100	3600
006220	2	100	3600
006237	3x2	100	2400
006244	3	100	2400
006251	4x3	60	1440
006268	4	100	1600
006275	5	20	480
006282	6	25	450
006299	8	10	200
006305	10	10	120
376569	12*	2	48
376576	15*	2	48

*ANACO Couplings

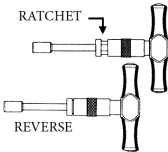

TORQUE WRENCH 60-inch Pounds

Part No.

006558

"Tyler Pipe Company strongly recommends that its hubless cast iron pipe and fittings be joined with shielded couplings manufactured in accordance with CISPI 310. The use of unshielded couplings or any coupling not meeting the above specifications will void the product warranty"



TY-SEAL

Part No.	Ea. Size	Carton Quantity	Pallet Quantity
004875	2	60	2880
004882	3	40	1600
004899	4	40	1280
004905	5	30	600
004912	6	30	600
004929	8	20	320
004936	10	10	270
004943	12	10	270
014959	15	10	120

EZ-TITE

Part No.	Ea. Size	Carton Quantity	Pallet Quantity
004950	2	60	2880
004967	3	40	1600
004974	4	40	1280
004981	5	30	600
004998	6	30	600

***NOTE:** Adhesive lubricants are required for TYSEAL and EZ-TITE gaskets in sizes 5-inch and larger diameters.



PIPE & COUPLING

SERVICE GASKETS, GASKET LUBRICANTS

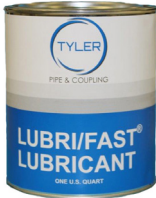

LUBRI/FAST® LUBRICANT

Part No.	Size
005148	Quart

LUBRI/FAST® LUBRICANT

- The unique **LUBRI/FAST®** formula makes joining TY-SEAL gaskets easier and faster because it's so slick! Applied as a liquid, **LUBRI/FAST®** actually reduces joining forces required; then it literally "fastens" the joint.
- **LUBRI/FAST®** is applied with an ordinary paint brush. It may be used for joining all pipe and fittings, and is **required** for joining all larger diameters 5" through 15".



TY-SEAL® LUBRICANT

Part No.	Size
005117	Quart

TY-SEAL® LUBRICANT

- An excellent water-soluble joint compound, TY-SEAL LUBRICANT has demonstrated its efficiency in millions of joints.
- Quick and easy to use under all conditions... even under water!



To Assemble Fittings:

Place yoke behind hub, adjust bar to length of fitting and pull handle to join in soil pipe.



Soil Pipe Puller

Part No.	Size
005155	2-3-4
393948	5-6-8



PIPE & COUPLING

SERVICE FITTINGS

CLEANOUT BODIES:

Standard Ferrule 2-11 is made according to Soil Pipe Standards. It is approved for use in all areas where codes do not require special local designs. Tapping sizes 2½, 3½, 4, 5 and 6 will admit conventional full opening test plugs.

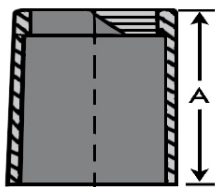

SV TAPPED SPIGOT

Part No.	Size	A
111719	4x2	4¼

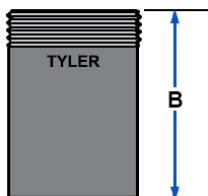

**2-41 SPIGOT ADAPTOR
(SV or No-Hub)**

Part No.	SP-IPB	B
024446	2-2	5½
024453	3-3	5½
024460	4-4	5½

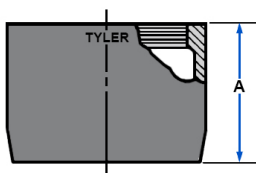

2-11 STANDARD FERRULE

Part No.	Pipe Size	Tap Size	A
023210	2	1½	3½
023234	3	2½	3¾
023258	4	3	3¼
023272	4	3½	4¼
023296	5	4	4¼
023319	6	5	4¼
023333	8	6	4½
023357	10	6	4½
023388	12	6	5¼
023371*	15	6	5¼

* XH Only; XH Multiplier

**2-11 STANDARD FERRULE
W/ TYPE A PLUG**

Part No.	Pipe Size	Tap Size	A
023395	2	1½	3½
023425	3	2½	3¾
023456	4	3	3¼
023487	4	3½	4¼
023517	5	4	4¼
023548	6	5	4¼
023586	8	6	4½
023609	10	6	4½
023630	12	6	5¼
023623*	15	6	5¼

* XH Only; XH Multiplier

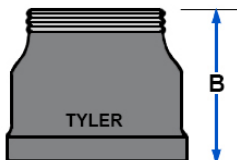

2-40 HUB ADAPTOR
Not Suitable for Ty-Seal®

Part No.	Hub	IPB
022121	2-2	4 ⁵ / ₈
022138	3-3	4 ⁵ / ₈
022145	4-4	4 ⁵ / ₈

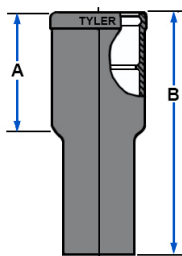

INSERTABLE JOINT (SV Only)

Part No.	Size	A	B
428336	2	6	14
024415	3	8	16
024422	4	7	14 ¹ / ₂
384731	5	9	15 ⁵ / ₈
383178	6	8 ¹ / ₂	16 ³ / ₁₆
102717	8	10	18

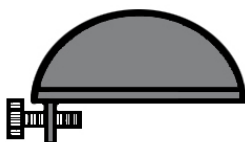

VENT CAP (w/SET SCREW)

Part No.	Fit Spigot
014591	4

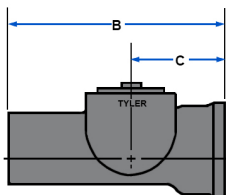

2-70 TEST TEE (SV Less Plug)

Part No.	Pipe Size	Tap Size	B	C
024507	2	2	10 ³ / ₈	4 ¹ / ₄
024521	3	3	12 ³ / ₄	5 ¹ / ₂
024545	4	3 ¹ / ₂	13 ⁵ / ₈	6
024569	*4	3 ¹ / ₂	11 ³ / ₄	5 ³ / ₄
024583	4	4	13 ⁷ / ₈	6
024576	*4	4	11 ³ / ₄	5 ³ / ₄
024606	5	5	15	7 ¹ / ₈
024613	6	6	16	7 ¹ / ₈
024637	8	8	20 ¹ / ₂	9 ¹ / ₂
024668	10	10	20 ¹ / ₂	9 ⁷ / ₈



PIPE & COUPLING

SERVICE FITTINGS

2-70 TEST TEE (W/ TYPE A PLUG)

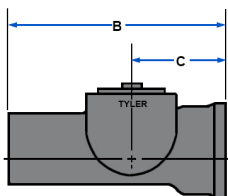

Part No.	Pipe Size	Tap Size	B	C
024675	2	2	10 ³ / ₈	4 ¹ / ₄
024699	3	3	12 ³ / ₄	5 ¹ / ₂
024750	4	3 ¹ / ₂	13 ⁷ / ₈	6
024712	*4	3 ¹ / ₂	11 ³ / ₄	5 ³ / ₄
024774	4	4	13 ¹ / ₈	6
024736	*4	4	11 ³ / ₄	5 ³ / ₄
024798	5	5	15	7 ¹ / ₈
024811	6	6	16	7 ⁷ / ₈
024835	8	8	20 ¹ / ₂	9 ¹ / ₂
025436	**10	10	20 ¹ / ₂	9 ⁷ / ₈
383079	† 12	8	22 ³ / ₄	9 ³ / ₄

*Short Laying Length

**Type "O" Plug Furnished

† Southern Raised Head

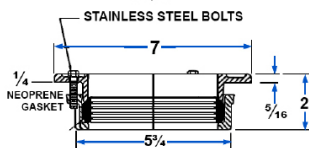
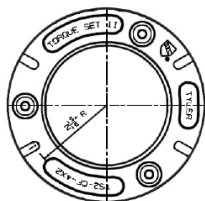

2-252TS
Torque Set Closet Flange
Fits 4" No-Hub or SV Pipe

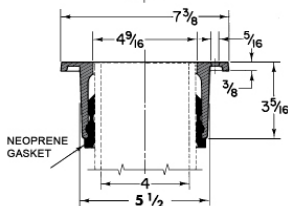
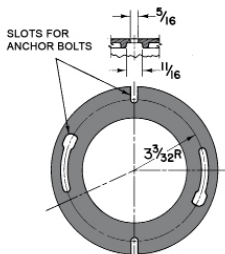

2-252TY*
Push-On Closet Flange

Part No.	Item	Size
022992	2-252TS	4x2 Torque Set
022954	2-252TY	4 Ty-Seal Hub*

* For minimum dimensions installed, see page 90

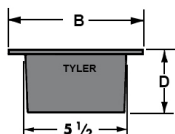
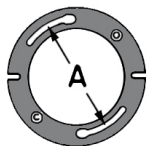

Regular

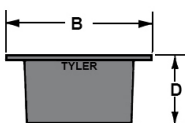
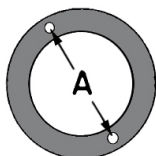

Portland

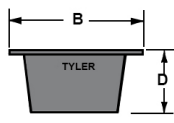
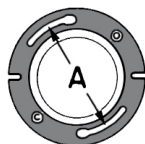

Reducing

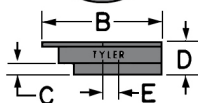
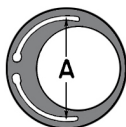

Offset 1"

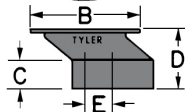
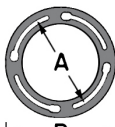

Offset 2"

2-252 CLOSET FLANGE (Caulk Joint Application)

Part No.	Size x Height	A	B	C	D	E
022848	4x1	6¼	7¼	...	1	...
022855	4x1½	6¼	7¼	...	1½	...
022862	4x2	6¼	7¼	...	2	...
022923*	4x2	6⅞	7¼	...	2	...
022879	4x2½	6¼	7¼	...	2½	...
022886	4x3	6¼	7¼	...	3	...
022893	4x4	6¼	7¼	...	4	...
022930*	4x4	6⅞	7¼	...	4	...
022909	4x5	6¼	7¼	...	5	...
022916	4x6	6¼	7¼	...	6	...
022978	4x2, 1" Offset	6	7	⅞	2	1
022985	4x4, 2" Offset	6¼	7¼	2	4	2
022947	4x3-3" Reducing	6¼	7¼	...	3	...

*Portland Code, two ¼" taps on top.



PIPE & COUPLING

CLOSET BENDS

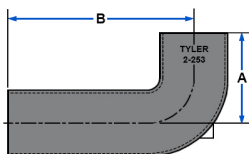

SERIES 2-253 PLAIN END CLOSET BENDS

Part No.	Size	Dimension	
		A	B
382621	3	16	16
025504	4	4	12
025511	4	4	14
025528	4	4	16
025535	4	4	18
025542	4	6	12
025566	4	6	15
025573	4	6	16
025580	4	6	18
025733	4	8	16
025757	4	10	12
025771	4	10	16
025788	4	10	18
025795	4	12	12
025801	4	12	14
025818	4	12	16
025825	4	12	18
025832	4	14	16
025849	4	14	18
025856	4	16	16
025863	4	16	18
025962	4	18	18

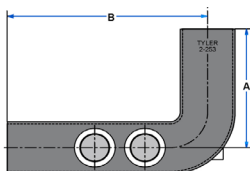
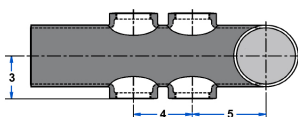
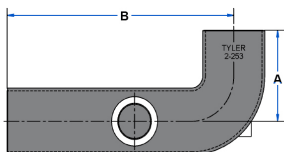
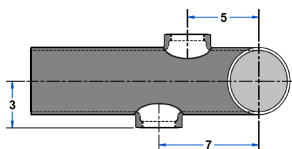

2-253 NORTHEAST SPECIAL SERIES CLOSET BENDS with 1½" or 2" Side Taps

Part No.	Size	Dimension Height(A) & Length(B)- TapWt.
025658	4	6x16xT2-2,LH,RH
276876	4	6x16xT4-1½,2LH,2RH
276883	4	6x16xT4-2,2LH,2RH
277439	4	6x24xT2-1½,LH,RH
025641	4	6x24xT2-2,LH,RH
360537	4	6x24,(NO TAPS)
025917	4	16x16xT2-1½,LH,RH
284789	4	16x16xT4-1½,2LH,2RH
277446	4	16x16xT4-2,2LH,2RH



PIPE & COUPLING

CLOSET BENDS BRASS CLEANOUT PLUGS



Example

MINIMUM DIMENSIONS FOR 2-252TY
PUSH-ON CLOSET FLANGE WHEN USED WITH 2-253 4" CLOSET BENDS

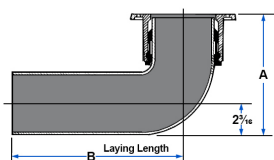

PUSH-ON CLOSET FLANGE INSTALLATION

2-253 CLOSET BENDS	A	B
4x6	8	12"-18"
4x8	10¼	12"-18"
4x10	12¼	12"-18"
4x12	14¼	12"-18"
4x14	16¼	16"-18"
4x16	18¼	16"-18"
4x18	20¼	18"

SERIES 2-254 PLAIN END REDUCING CLOSET BENDS

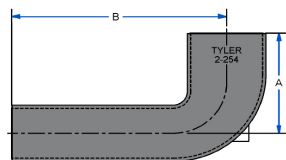

Part No.	Size	A	B
025979	4x3	6	12
025986	4x3	6	15
025993	4x3	6	16
026006	4x3	6	18
026037	4x3	10	12
026044	4x3	10	15
026068	4x3	10	18
026075	4x3	12	12
026099	4x3	16	16
026129	4x3	18	18



TYPE H FOUR LUG FLANGE

Part No.	IPS	B	C	Lug
333258	2	½	⅝	2
333272	3	½	⅝	4
333289	3½	½	⅝	4
333296	4	⅝	⅝	4
333302	5	¾	1	4
333319	6	⅝	1	4

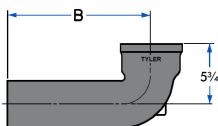

SERIES 2-256 CLOSET BENDS SV Only

Part No.	Size	Dimension B
026136	4	12
026143	4	14
026150	4	16
026167	4	18

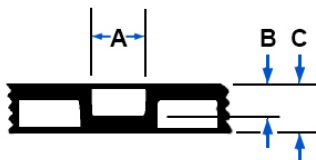

TYPE S PLAIN COUNTERSUNK

Part No.	IPS	A	B	C
021896	1½	1¼	5/16	3/8
021902	2	¾	5/16	7/16
021919	2½	¾	5/16	7/16
021926	3	7/8	5/16	15/32
021933	3½	15/16	3/8	½
021940	4	7/8	3/8	½
021957	5	1⅛	3/8	½
021964	6	17/16	½	5/8
021971	8	17/16	½	¾

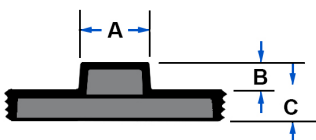

TYPE A LOW SQUARE HEAD

Part No.	IPS	A	B	C
021551	1¼	1¼	5/16	13/32
021568	1½	¾	5/16	3/8
021575	2	15/16	5/16	7/16
021582	2½	1	5/16	7/16
021599	3	1⅛	7/16	15/32
021605	3½	1⅛	3/8	½
021612	4	13/32	3/8	½
021629	5	13/8	7/16	½
021636	6	13/8	½	5/8
021643	8	15/8	½	¾
021889	10*	2	1	¾

* Type "O"



1. Question: From what elastomers are the sealing sleeves for the Standard NO-HUB and HUSKY couplings made, and what is the highest water temperature that it will handle?

Answer: The gasket elastomer used in the manufacture of the NO-HUB and HUSKY sealing sleeves is Neoprene in accordance with ASTM C 564. The properties of Neoprene make it suitable for moderate chemicals and acids, oil fats, greases, many solvents and air with hydrocarbons. Neoprene will not support combustion. The maximum temperature that Neoprene will accommodate with continuous service is 203°F. with a maximum intermittent temperature of 212°F. Neoprene is the only gasket elastomer offered with these couplings.

2. Question: From what elastomer are the standard TY-SEAL and EZ-TITE gaskets made and what is the highest water temperature they will handle? Are these gaskets available in other elastomers?

Answer: The elastomer used in the manufacture of the TY-SEAL and EZ-TITE gaskets is Neoprene in accordance with ASTM C 564. The properties of Neoprene make it suitable for moderate chemicals and acids, oil fats, greases, many solvents and air with hydrocarbons. Neoprene will not support combustion. The maximum temperature that Neoprene will accommodate with continuous service is 203°F with a maximum intermittent temperature of 212°F. Neoprene is the only elastomer that Tyler Pipe offers with EZ-TITE gaskets. Tyler does offer the TYSEAL gaskets in Buna-N (also known as Nitrile or NBR) which afford a 239° continuous service temperature maximum. Buna-N gaskets are suitable for gasoline, diesel, petroleum products, hydrocarbons, mineral water and vegetable oils.



3. Question: What is the pressure rating for the NO-HUB and HUSKY couplings?

Answer: Couplings for Drain, Waste and Vent are not pressure rated. They are designed to hold 4.3 psi (10 ft. of head) for hydrostatic testing purposes as stated in CISPI 310. The NO-HUB, HUSKY 2000 and HUSKY 4000 couplings meet the performance criteria of FM 1680, all classes.

4. Question: What is the pressure rating for the TY-SEAL and EZ-TITE compression gaskets for hub and spigot joints?

Answer: Drain, Waste and Vent compression gaskets for Service Weight pipe and fittings (TY-SEAL and EZ-TITE) are not pressure rated. They are designed to hold 4.3 psi (10 ft. of head) for hydrostatic testing purposes as recommended in the Cast Iron Soil Pipe Institute Handbook.

5. Question: Are the couplings sold by Tyler Pipe for hubless applications UL or FM approved?

Answer: No plumbing code requires UL certification for couplings. All couplings manufactured by Tyler Pipe meet the performance requirements of FM 1680, all classes, however they are not listed by Factory Mutual.

6. Question: If there is no pressure rating for TY-SEAL/ EZ-TITE Gaskets or NO-HUB couplings, what will keep the joints from separating if a line backs up?

Answer: It is necessary to understand the difference between pressure and thrust. Thrust is equal to the hydrostatic pressure (4.3 psi @ 10 ft. of head) multiplied by the area. As a cylinder is filled with water, thrust forces are exerted on all changes of direction, bends, branches, fittings with reductions and ends of runs,



These locations must be restrained in order to prevent joint movement or separation. On a vertical run, the weight of the pipe helps to stabilize the joints on the run, but proper restraints are still necessary.

7. Question: Are the couplings sold by Tyler Pipe for hubless applications fire protection rated?

Answer: No. Since the Neoprene sleeve is completely protected by a non-flammable stainless steel shield, fire rating is not required.

8. Question: Is adhesive lubricant required to join SV pipe and fittings with TY-SEAL or EZ-TITE gaskets?

Answer: Tyler Pipe requires the use of adhesive lubricants for sizes 5" diameter and larger. On sizes 2" through 4", regular non-adhesive lubricant may be used.

9. Question: Does Tyler sell an adhesive lubricant?

Answer: Yes. Tyler offers LUBRIFAST® LUBRICANT which affords easy installation application while literally "fastening" the joint.

10. Question: Can I use an adhesive lubricant with NO-HUB couplings?

Answer: Tyler Pipe Company does not require or encourage the application of any type of lubricant with NO-HUB couplings. Although lubricants will have no adverse effect on cast iron pipe and fittings or the Neoprene sleeve of the coupling, some codes will not allow any lubricant to be applied to NO-HUB couplings. Before using any lubricant with NO-HUB or any other hubless coupling connector, check the applicable codes for restrictions.



11. Question: What is the maximum deflection of an SV or NO-HUB joint?

Answer: 5° per joint is the maximum allowable deflection for SV and NO-HUB connections.

12. Question: What coating does Tyler apply to its pipe and fittings?

Answer: Tyler Pipe applies a smooth even layer of bituminous petroleum asphalt coating through a dipping process for each piece of SV and NH pipe and all fittings. This coating affords a measure of corrosion protection as well adding cosmetic value.

13. Question: What is Tyler's recommended procedure for hydrostatic testing of SV and NH pipe?

Answer: Ten feet of head for 15 minutes, properly restrained, as referenced in the Cast Iron Soil Pipe Institute Handbook.

14. Question: Can Tyler Pipe's hubless pipe, fittings and NO-HUB Couplings be used below grade?

Answer: Yes! None of the model codes place any restriction(s) on the use of hubless pipe, fittings or couplings below grade. However, it is advised to first check with the local jurisdictional code before installation to ensure that no local restrictions have been placed on hubless below grade applications.



PIPE O.D.'S

Because many items listed are not made by Tyler Pipe, we cannot be certain that all data is current or accurate. Please check with the product manufacturer for their most recent information.

PIPE O.D. CHART										PIPE O.D. CHART										
GRAY/PIR					CAST IRON/NDV					PLASTIC (PVC)					PLASTIC (PVC)					
CLASSES		OD.	SV	NI	XH	C-900		C-905	D.I.O.D.	DR.41		DR.41		DR.41		DR.41		DR.41		
PIPE SIZE	PIT	SPUN				DR.25 CLASS 200	DR.10 CLASS 150	DR.14 CLASS 200	4.118-5.0	DR.41	DR.41	DR.41	DR.41	DR.41	DR.41	DR.41	DR.41	DR.41	DR.41	
1 1/2"						1.50±.05														
2"						2.30±.05	2.30±.05	2.30												
2 1/2"																				
3"	A		3.80±.05		3.30±.05	3.30±.05	3.30±.05	3.30												
3"	B,C,D	50-350	3.95																	
3 1/2"	A		4.80±.05		4.30±.05	4.30±.05	4.30±.05	4.30	4.80											
4"	B,C,D	5.00			-.05															
5"						5.30±.05	5.30±.05	5.30												
6"	A	50-350	6.90			6.30±.05	6.30±.05	6.30	6.90											
6"	B,C,D	7.10			-.05															
6"	E,F	7.25																		
8"	A,B	50-300	9.05		8.30±.13	8.30±.13	8.62	9.05												
8"	C,D	350	9.30		-.09															
8"	E,F	9.42																		
10"	A,B	50-200	11.10			10.50±.13	10.50±.09	10.75	11.10											
10"	C,D	250-350	11.40																	
10"	E,F	11.60																		
12"	A,B	50-200	13.20		12.50±.19	12.50±.13	12.75	13.20												
12"	C,D	250-350	13.50																	
12"	E,F	13.78																		
14"	A,B	50-100	15.30						15.30											
14"	C,D	150-300	15.65																	
14"	E,F	15.95																		
15"	A,B	50-100	17.40			15.88±.19	15.83±.13	15.85	17.40											
16"	C,D	150-300	17.80																	
16"	E,F	18.10																		
18"	A,B	50-100	19.50						19.50											
20"	C,D	150-250	19.92						21.60											
20"	A,B	50-100	21.60																	
20"	C,D	150-250	22.06						22.047											
21"	A,B	50-100	25.80						25.80											
24"	C,D	150-250	26.32																	
24"	A,B	50-100	26.32																	
24"	C,D	150-250	26.32						27.953											
24"	A,B	50-100	26.32																	
24"	C,D	150-250	26.32																	



Bracing:

To prevent movement, horizontal pipe and fittings 5" and larger should be suitably braced by the use of blocks, rodding or other suitable methods at every branch or change of direction.

Test:

For best results, test one floor (ten feet) at a time. The system should be properly restrained; all bends, changes of direction and ends of runs should be restrained.

Gasket Material:

Ez-Tite gaskets are made of Neoprene as the sole elastomer. The physical characteristics of the Neoprene ensure that the gasket will not decay or deteriorate from contact with effluents in the pipe or chemicals in the soil or air around the pipe.

Description:

Ez-Tite is a one-piece compression gasket. It is used for joining hub and spigot cast iron soil pipe and fittings made according to ASTM A 74.

Gasket Specification:

Ez-Tite gaskets conform strictly to ASTM Standard C 564, latest issue.

Joint Characteristics:

Gasket joints will not leak even if deflected as much as 5 degrees, or when subjected to vibration, seismic tremors, expansion, contraction, external or internal test pressure.

How to Specify:

All 2-inch through 6-inch hub and spigot cast iron soil pipe and fittings shall conform to ASTM A 74; joints shall be made either by caulked lead and oakum or by compression gaskets which conform to ASTM C 564.

NOTE: An adhesive lubricant is required for TY-SEAL and EZTITE gasket sizes 5-inch and larger diameters. Tyler offers LUBRI/FAST® LUBRICANT for this application.

Physical Properties:

Property		Performance Requirement		ASTM Test Method
Hardness (nominal durometer ± 5) as specified by the pipe manufacturer	50	60	70	D2240
Elongation, min, percent	350	300	250	D412
Tensile strength, min, psi (MPa)	1500	1500 (10)	1500 (10)	D412 (10)
Tear Resistance, min, lbf/in. (N/cm)	150 (268)	150 (268)	150 (268)	D624
Compression set, max, percent	25	25	25	D395
Heat aging, 96 h at 158° \pm 2° F (70° \pm 1° C)				D573
Hardness, increase, max, durometer pts	10	10	10	
Loss in tensile strength, max, percent	15	15	15	
Loss in elongation, max, percent	20	20	20	
Water absorption: Weight increase, max, percent	20	20	20	D471
Ozone resistance no cracks	no cracks	no cracks		D1149
Oil immersion: Volume increase, max, percent	80	80	80	D471



Description:

TY-SEAL is a one-piece compression gasket. It is used for joining hub and spigot cast iron soil pipe and fittings made according to ASTM A 74.

Gasket Material:

TY-SEAL gaskets are made of Neoprene as the sole elastomer. The physical characteristics of the Neoprene ensure that the gasket will not decay or deteriorate from contact with effluents in the pipe or chemicals in the soil or air around the pipe.

Gasket Specification:

TY-SEAL gaskets conform strictly to ASTM Standard C 564, latest issue. The TYSEAL mill specification meets or exceeds all requirements.

Bracing:

To prevent movement, horizontal pipe and fittings 5" and larger should be suitably braced by the use of blocks, rodding or other suitable methods at every branch or change of direction.

Pipe Specification:

TYLER hub and spigot cast iron soil pipe and fittings comply with the latest issue of ASTM A 74, ANSI A 112.5.1 and Federal Specification WW-P-401 E.

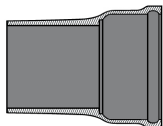

1. Clean hub and spigot to be joined.



2. Insert gasket in the hub, lubricate inside the gasket

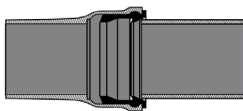

3. Align hub and spigot.

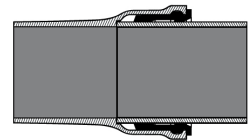
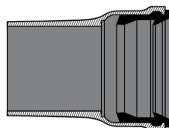

4. Pull or push spigot through the gasket until firmly sealed.



SUBMITTAL TY-SEAL GASKETS, HUB & SPIGOT CAST IRON SOIL PIPE & FITTINGS

Tyler Pipe/Soil Pipe Division • 11910 CR 492 • Tyler, TX 75706 • (800) 527-8478

Physical Properties of Ty-Seal Gaskets:

Physical Property	Test Method	Performance Requirements
Hardness, durometer A	ASTM D 2240	70 ± 5 points
Tensile Strength	ASTM D 412	1500 psi. minimum
Elongation of break	ASTM D 412	250% minimum
Tear Resistance	ASTM D 624 (Die C)	150 lbs. per lin. inch minimum
Resistance to heat aging	ASTM D 573	
Change in original properties after 96 hrs. at 158° F.		
Hardness		± 10 points maximum
Elongation		-20% maximum
Tensile strength		-15% maximum
Resistance to oil aging	ASTM D 471	
Change in volume after 70 hrs. immersion in ASTM Oil No. 3 at 212° F.		80% maximum
Resistance to ozone	ASTM D 1149	
Condition after exposure to 150 pphm ozone in air for 100 hrs at 140° F. (40° C.) (sample under 20% strain)		No cracks
Resistance to permanent set	ASTM D 395	25% maximum
Compression set after 22 hrs. at 158° F.	(Method B)	
Compression set after 22 hrs. at 14° F.	ASTM D 1229	60% maximum

Joint Characteristics:

TY-SEAL gasket joints will not leak even if deflected as much as 5 degrees, or when subjected to vibration, seismic tremors, expansion, contraction, external or internal test pressure.

Quality Control:

Company laboratory tests insure that finished gaskets conform to specification.

Availability of Products:

Cast iron soil pipe and TY-SEAL gaskets are sold through recognized plumbing distribution channels.

Plumbing Codes:

National plumbing codes and government agencies now provide for gasket joints.

Documents:

Certificates and reports validating all statements contained herein will be supplied on written request.

HOW TO SPECIFY:
All 2-inch through 15-inch hub and spigot cast iron soil pipe and fittings shall conform to ASTM A 74; joints shall be made either by caulked lead and oakum or by compression gaskets such as TY-SEAL which conform to ASTM C 564.





SUBMITTAL TYLER® STANDARD NO-HUB COUPLINGS

Tyler Pipe/Soil Pipe Division • 11910 CR 492 • Tyler, TX 75706 • (800) 527-8478



Description:

Tyler Pipe standard no-hub couplings are manufactured in accordance with CISPI 310 and are designed to join cast-iron pipe and fittings in drain, waste and vent applications. Each coupling includes two components: a molded, one-piece neoprene sealing sleeve and a 300 series AISI stainless steel shield/ clamp assembly featuring compression bands over our trademark diamond-corrugation shield pattern. No-hub couplings are available in sizes from 1½" to 15" in diameter.

Neoprene Sealing Sleeve:

Tyler Pipe standard-coupling sealing sleeves conform to ASTM standard C 564 and are made of high-purity neoprene. This material delivers superior resistance to decay and deterioration from contact with effluents in the pipe, chemicals in the soil, or air around the pipe - including oil and other petroleum products. Also, neoprene can withstand high liquid temperatures up to 212°, is fire resistant and does not support flame. Each sleeve features a double row of raised, sealing rings positioned under each compression band to provide multiple, sealing surfaces on either side of the connection. This ensures a permanent, leak-proof joint that can reliably accommodate minor, pipe-mating diameter variations.

Shield and Clamp Assembly:

Tyler® couplings incorporate a shield and clamp assembly fabricated from 300 series stainless steel for maximum corrosion resistance. Clamping bands are mounted and attached to the shield by a fixed and floating eyelet system that allows for variable adjustment of each clamp during tightening. Our shield's patented diamond-pattern corrugation design locks the sealing sleeve under the shield and prevents slippage or extrusion - even under elevated internal pressure or external stress. The clamp bands on 1½"- 10" diameter couplings require 60 in-lbs of torque. 12"-15" diameter couplings require 80 in-lbs of torque.

Material Specification:

Bands	300 Series AISI Stainless Steel
Screw Housing	300 Series AISI Stainless Steel ½ " hex head slant shoulder
Shield	300 Series AISI Stainless Steel
Sealing Sleeve	Neoprene elastomer compound conforms to ASTM C 564

Bracing:

Horizontal pipe and fittings 5" and larger should be suitably braced using blocks, rodding or other methods at each branch or change in direction.



SUBMITTAL TYLER® STANDARD NO-HUB COUPLINGS

Tyler Pipe/Soil Pipe Division • 11910 CR 492 • Tyler, TX 75706 • (800) 527-8478

Suggested Specification:

No-hub cast-iron soil pipe and fittings shall be joined with Tyler Pipe NSF certified couplings that conform to the CISPI 310 / ASTM C1277 standard. Couplings will be installed according to the installation instructions of the manufacturer. All pipe and fittings on which couplings are installed shall bear the registered trademark \times signifying they comply with the Cast Iron Soil Pipe Institute Standard 301.

Joint Characteristics:

A superior gasket joint is produced with a Tyler Pipe standard no-hub coupling. It is designed not to leak, even when subjected to vibration, seismic tremors, expansion, contraction, deflection by as much as 5 degrees, or external and internal test pressure.

Quality Control and Documentation:

Tyler Pipe's internal quality control processes include daily performance testing to verify conformance of all components to established standards. In addition, NSF periodically tests, inspects and audits Tyler Pipe's manufacturing facility. Certificates and reports validating all claims contained in this Submittal will be supplied upon written request.

PHYSICAL PROPERTIES

Property	Value	ASTM Test Method
Tensile Strength	1500 psi minimum	D 412
Elongation of Break	250% minimum	D 412
Hardness, Durometer (A)	70 \pm 5 at 76° \pm 5° F	D 2240
Tear Resistance	150 lbs. per inch, min	D 624 (Die C)
Water Absorption (Wt. Change, 20% maximum 7 days at 158° F)	20% maximum	D 471
Resistance to Heat Aging (Change in original properties after 96 hrs. at 158° F)		D 573
Hardness	10 points, maximum	
Elongation	20% maximum	
Tensile Strength	15% maximum	
Resistance to Oil Aging (Change in volume after 70 hrs. immersion in ASTM oil IMR903 at 212° F)	80% maximum	D 471
Resistance to Ozone (Condition after exposure to 1.0 pphm ozone in air for 100° F - Loop-mounted sample approximately or 20% elongation)	No Cracks at 2x Magnification	D 1149
Resistance to Permanent Set (Compression set after 22 hrs. at 158° F)	25% maximum	D 395 (Method B)

Specifications:

All 1½ inch diameter and larger cast iron soil pipe and fittings for above and below grade soil, waste, vent lines, rain water conductors and storm drainage lines shall bear the registered insignia ☿ or × NO HUB® indicating that these items used in the sanitary system comply with the Cast Iron Soil Pipe Institute Standards 301 or ASTM A888.

Standards:

CISPI 301: Hubless Cast Iron Soil Pipe & Fittings

ASTM A 888: Hubless Cast Iron Soil Pipe & Fittings

ASTM C 564: Rubber Gaskets for Cast Iron Soil Pipe & Fittings



NO-HUB PIPE, TEN-FOOT LAYING LENGTH

Size	Wt. per 10'*	Per Bundle	
		Pieces	Wt. lbs.
1½	30	54	1620
2	36	64	2304
3	52	48	2496
4	74	30	2220
5	94	24	2256
6	110	21	2310
8	180	15	2700
10	258	8	2064
12	325	6	1950
15	472	3	1416

*Note: Weights approximate, for shipping purposes only.

NO-HUB, TEN-FOOT LAYING LENGTH DIMENSIONS AND TOLERANCES

Size	Hubless Pipe Barrels		
	B Inside Diameter	J Outside Diameter	T Thickness Nom. Min.
1½	1.50±.09	1.90±.06	.16 .13
2	1.96±.06	2.35±.09	.16 .13
3	2.96±.06	3.35±.09	.16 .13
4	4.00±.06	4.38±.09-.05	.19 .15
5	4.94±.09	5.30±.09-.05	.19 .15
6	5.94±.09	6.30±.09-.05	.19 .15
8	7.94±.13	8.38±.13-.09	.23 .17
10*	10.00±.13	10.56±.09	.28 .22
12	11.94±.09	12.50±.09	.28 .22
15	15.11±.09	15.83±.09	.36 .30

* O.D. Barrel out of round tolerance of ±.04 is permitted.



IAPMO Figure Six
Right/Left &
Double (Full Baffle)



Quarter Bend



Threaded Vertical
Starter



P-Trap
w/1/2" Primer Tap



Wye



San Tee



Short Sweep



San Cross



Blind Plug



IAPMO Figure One
w/No-Hub Top



Short Reducer



Eighth Bend

NOTE: Tyler Pipe Company strongly recommends that its hubless cast iron pipe & fittings be joined with shielded couplings manufactured in accordance with CISPI 310. The use of unshielded couplings or any coupling not meeting the above specifications will void the product warranty.



SUBMITTAL
♀ HUB-SPIGOT®
CAST IRON SOIL PIPE & FITTINGS

Tyler Pipe/Soil Pipe Division • 11910 CR 492 • Tyler, TX 75706 • (800) 527-8478

Specifications:

All 2 inch through 15 inch hub & spigot cast iron soil pipe and fittings shall conform to ASTM A 74; joints shall be made either by caulked lead and oakum or by compression gaskets such as TY-SEAL® which conform to ASTM C 564.

Standards:

ASTM A 74 : Cast Iron Soil Pipe & Fittings

ASTM C 564 : Rubber Gaskets for Cast Iron Soil Pipe & Fittings

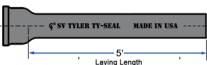
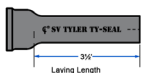

DOUBLE HUB, 30" LENGTHS

Size	L	Wt.
2"	25	12
3"	24½	17
4"	24	26

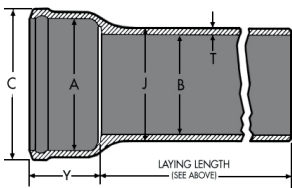

SV CLASS SINGLE HUB PIPE

Size	3-1/2 Ft.		5 Ft.		10 Ft.	
	A	B	A	B	A	B
2	15	2	20	2	38	3
3	23	3	31	3	52	4
4	30	4	42	4	76	5
5	39	5	55	5	97	6
6	45	6	62	6	115	8
8	72	8	100	8	190	10
10	106	10	150	10	270	12
12	35	12	190	12	355	15
15	184	15	260	15	515	

	Telescoping Length	Hub I.D.	Hub O.D.	Barrel O.D.	Barrel I.D.	Nominal Thickness	Minimum Thickness
Size	Y	A	C	J	B	T	T
2"	2.50	2.94	3.62	2.30	1.96	0.17	0.14
3"	2.75	3.94	4.68	3.30	2.96	0.17	0.14
4"	3.00	4.94	5.68	4.30	3.94	0.18	0.15
5"	3.00	5.94	6.68	5.30	4.94	0.18	0.15
6"	3.00	6.94	7.68	6.30	5.94	0.18	0.15
8"	3.50	9.25	10.13	8.38	7.94	0.23	0.17
10"	3.50	11.38	12.44	10.50	9.94	0.28	0.22
12"	4.25	13.50	14.56	12.50	11.94	0.28	0.22
15"	4.25	16.95	18.11	15.88	15.16	0.36	0.33

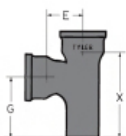

San Tee

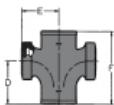

Tapped San Cross

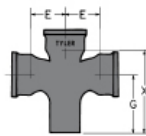

San Cross
(No Baffles)



Reducer



P Trap

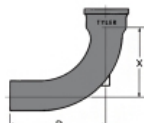

Long Sweep Bend

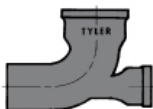

Quarter Bend
w/ Low Heel Inlet



Wye

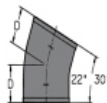

Sixteenth Bend

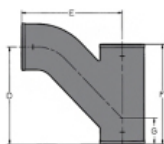

Combination

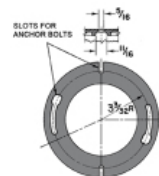

Push-On
Closet
Flange

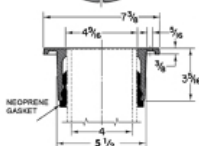



TylerPipe.com

1. SEARCH INVENTORY for all soil pipe products in stock, 24 hours a day, 7 days a week.

2. SEE THE ENTIRE TYLER DWV CATALOG
View, print and download drawings and specifications.

3. FIND THE COMPLETE LIST PRICE SHEET
Use the Index to go right to the product group you need. Then you can view, print, or download them.

Stock check now takes just seconds. You can use either the part numbers in the Price Sheets, or search by product description.

STANDARDS & SPECIFICATIONS

Piping to be installed for the various services shall be as specified or in accordance with local plumbing codes:

CURRENT STANDARDS

¶ NO-HUB® Cast Iron Soil Pipe and Fittings:

- CISPI 301 (Cast Iron Soil Pipe Institute)
- ASTM A 888 (American Society for Testing and Materials)

SV Hub and Spigot Cast Iron Soil Pipe and Fittings:

- ASTM A 74 (American Society for Testing and Materials)

¶ NO-HUB® Couplings

- CISPI 310 (Cast Iron Soil Pipe Institute)
- ASTM C 1277 (American Society for Testing and Materials)
- ASTM C 1540 (American Society for Testing and Materials)

Hub & Spigot Gaskets:

- ASTM C 564 (American Society for Testing and Materials)



NO-HUB® Couplings

Cast Iron NO-HUB® Pipe & Fittings

Cast Iron NO-HUB® RufWall Special Fittings

TY-SEAL® and EZ-TITE® Gaskets

Cast Iron Hub and Spigot Pipe and Fittings

Cast Iron Chicago RufWall Special Fittings

Cast Iron Staple Specials

Technical Information and Submittal Data

Scan here to visit our website:



2024

Distributed By